

# BATCO

## تامین ابزار باوند



تهران، خیابان امام خمینی  
روبروی وزارت امور خارجه



مرکز فروش: ۰۲۱-۶۶۷۰ ۸۵۲۴  
فکس: ۰۲۱-۵۵۳۹ ۳۰۷۸

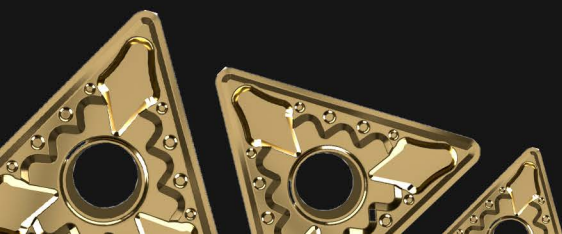



**江西江钨硬质合金有限公司**  
JIANGXI JIANGWU CEMENTED CARBIDE CO.,LTD  
Add:JingAn Industrial Zone,Jiangxi,China  
Post code: 330600  
Tel:86-795-4652929 4713958  
Fax:86-795-4668699  
E-mail:www.jxjtc.com  
Website:jxjw@jxjtc.com



CUTTING TOOLS

2015 VERSION



# CUTTING TOOLS

■ Turning tools    ■ Milling tools

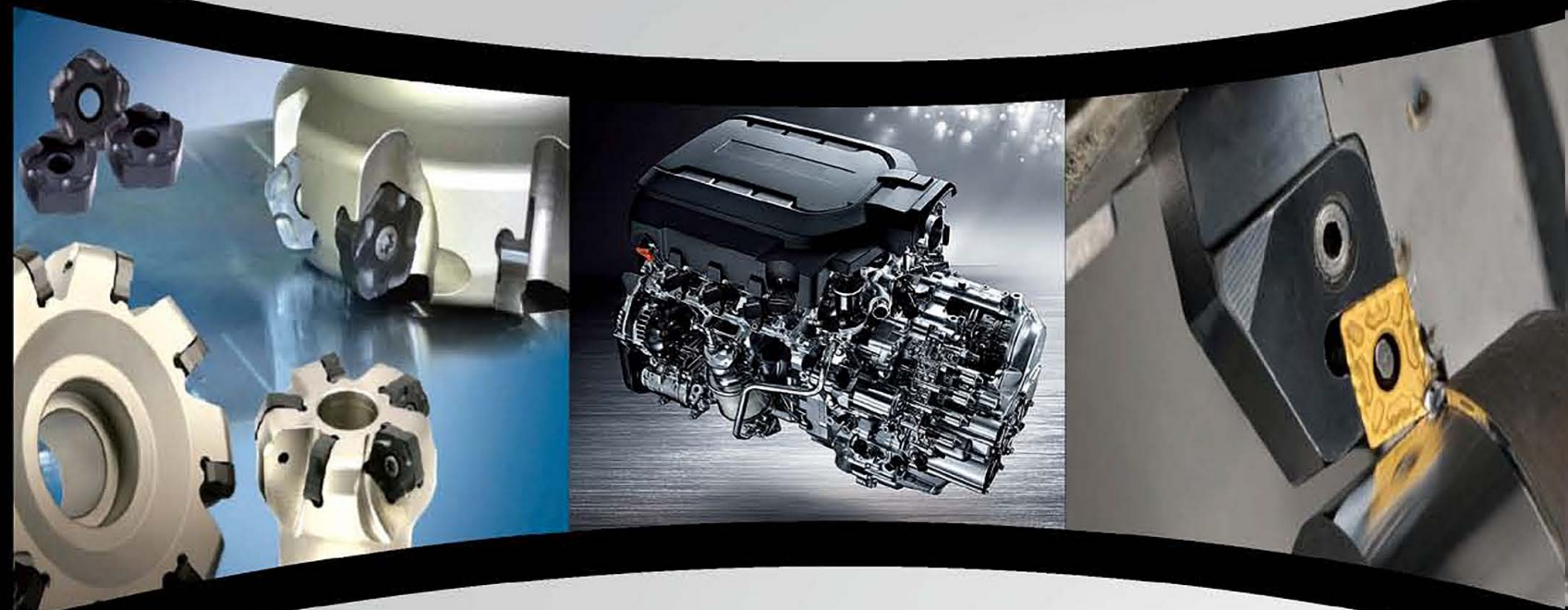

2015 VERSION

**江西江钨硬质合金有限公司**  
JIANGXI JIANGWU CEMENTED CARBIDE CO.,LTD

# Contents

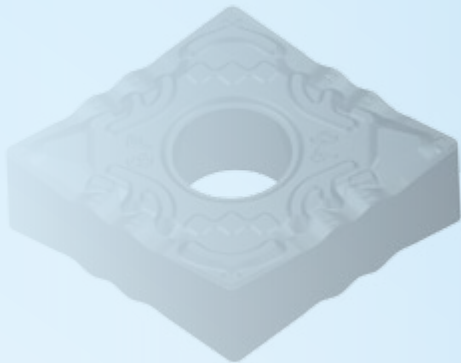

## A Turning A1-A356



## B Milling B1-B452

## C Technical information C1-C26

A2-A62	Common turning inserts
A150-A182	Parting and grooving inserts
A183-A226	Threading turning inserts

B1-B124	Indexable milling inserts
---------	---------------------------

C1-C24	Technical information
--------	-----------------------



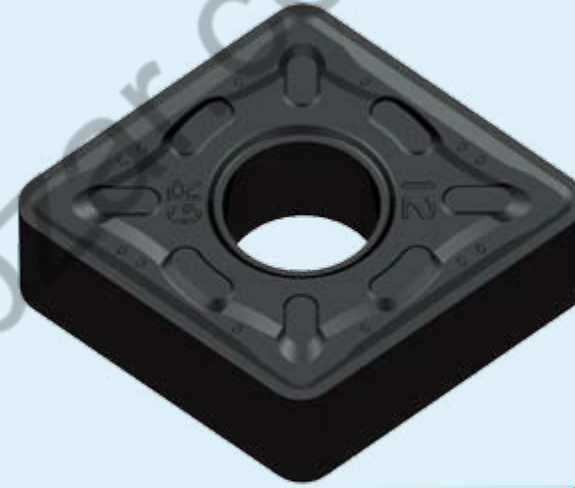
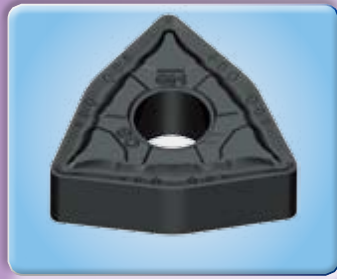
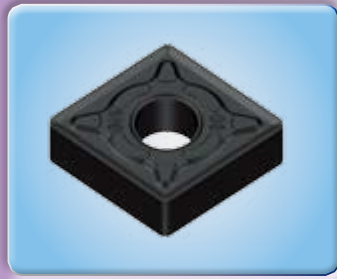
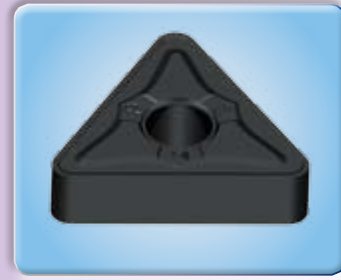
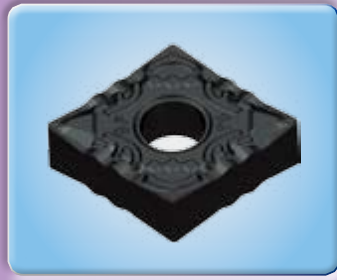
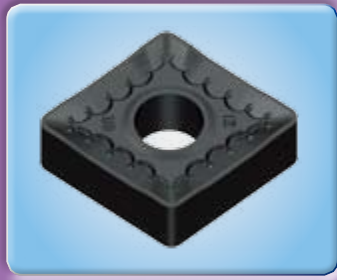

● Turning inserts overview	A2-A6
● Turning toolholders overview	A7-A10
● Recommended grade overview	A11
● Common turning inserts	A12-A148
Description of chipbreaker	A13-A14
Application notes	A15-A22
Common turning inserts	A24-A62
Cermented carbide inserts	A24-A62

Application data	A144-A148
● Parting and grooving tools	A150-A182
Parting and grooving tools	A151-A153
Parting and grooving inserts	A156-A165
Parting and grooving tools	A166-A182
● Threading machining tools	A183-A226
Threading tools overview	A184-A186
Threading inserts	A188-A208
Threading tools	A209-A226
● General technical information	A227-A234



# Turning Turning inserts overview

# Turning inserts overview Turning

## Cemented carbide and cermet inserts

<b>Rough</b>								
	<b>CNMG-GR</b>	<b>CNMM-GR</b>	<b>CNMG-BR</b>	<b>CNMG-KR</b>	<b>DNMG-GR</b>	<b>DNMM-GR</b>	<b>DNMG-BR</b>	
Length of cutting edge	09,12	12,16,19,25	12,16,19	12,16,19	15	15	15	
Page	A26	A26	A26	A27	A30	A30	A30	
	<b>DNMG-KR</b>	<b>SNMG-GR</b>	<b>SNMM-GR</b>	<b>SNMG-BR</b>	<b>SNMG-KR</b>	<b>TNMG-GR</b>	<b>TNMM-GR</b>	<b>TNMG-BR</b>
Length of cutting edge	15	12,15,19	12,15,19,25	12,15,19	12,15,19	16,22,27	16,22,27	16,22
Page	A30	A34	A34	A35	A35	A38	A38	A38
	<b>TNMG-KR</b>	<b>WNMG-GR</b>	<b>WNMG-BR</b>	<b>WNMG-KR</b>				
Length of cutting edge	16,22	06,08	06,08	06,08				
Page	A39	A43	A43	A43				
<b>Semi-finishing</b>								
	<b>CNMG-GM</b>	<b>CNMG-GS</b>	<b>CNMG-BM</b>	<b>DNMG-GM</b>	<b>DNMG-GS</b>	<b>DNMG-BM</b>	<b>SNMG-GM</b>	
Length of cutting edge	09,12	09,12	09,12	11,15	11,15	11,15	09,12,,15,19	
Page	A28	A28	A29	A31	A32	A32	A36	
	<b>SNMG-GS</b>	<b>SNMG-BM</b>	<b>TNMG-GM</b>	<b>TNMG-GS</b>	<b>TNMG-BM</b>	<b>VNMG-GM</b>	<b>VNMG-BM</b>	<b>WNMG-GM</b>
Length of cutting edge	12,15	12,15	11,16,22	16,22	11,16,22	16	16	06,08
Page	A36	A37	A40	A40	A40	A42	A42	A44
	<b>WNMG-BM</b>							
Length of cutting edge	06,08							
Page	A44							
<b>Finishing</b>								
	<b>CNMG-GF</b>	<b>CNMG-BF</b>	<b>DNMG-GF</b>	<b>DNMG-BF</b>	<b>SNMG-GF</b>	<b>SNMG-BF</b>	<b>TNMG-GF</b>	
Length of cutting edge	09,12	09,12	11,15	11,15	12	09,12,15	16,22	
Page	A29	A29	A33	A33	A37	A37	A41	

<b>Rough</b>							
	<b>TNMG-BF</b>	<b>VNMG-GF</b>	<b>VNMG-BF</b>	<b>WNMG-GF</b>	<b>WNMG-BF</b>		
Length of cutting edge	11,16,22	16	16	06,08	06,08		
Page	A41	A42	A42	A45	A45		
<b>Semi-finishing</b>							
	<b>CNMG</b>	<b>DNMG</b>	<b>SNMG</b>	<b>TNMG</b>	<b>VNMG</b>	<b>WNMG</b>	
Length of cutting edge	12,16,19	15,19	09,12,15,19,25	11,16,22,27,33	16	06,08	
Page	A27	A30	A35	A39	A42	A44	
<b>Rough</b>							
	<b>CNMA</b>	<b>DNMA</b>	<b>SNMA</b>	<b>TNMA</b>	<b>WNMA</b>	<b>RNMA</b>	
Length of cutting edge	12,16,19	11,15	09,12,15,19	16,22,27	06,08	12	
Page	A28	A31	A36	A39	A43	A46	
<b>Semi-finishing</b>							
	<b>KNUX</b>						
Length of cutting edge	16						
Page	A46						
<b>Rough</b>							
	<b>CCMT-HR</b>	<b>DCMT-HR</b>	<b>SCMT-HR</b>	<b>TCMT-HR</b>			
Length of cutting edge	09,12	07,11	09,12	09,11,16			
Page	A47	A50	A52	A54			
<b>Semi-finishing</b>							
	<b>CCMT-HM</b>	<b>DCMT-HM</b>	<b>SCMT-HM</b>	<b>TCMT-HM</b>	<b>VCMT-HM</b>	<b>VBMT-HM</b>	<b>CPMT-HM</b>
Length of cutting edge	06,09,12	07,11	09,12	09,11,16	11	11,16	06,09
Page	A47	A50	A52	A54	A57	A58	A59
	<b>DPMT-HM</b>	<b>SPMT-HM</b>	<b>TPMT-HM</b>				
Length of cutting edge	07,11	09,12	09,11				
Page	A60	A61	A62				

Negative angle

Negative angle

Positive angle







# Turning Turning inserts overview



A

Common turning Turning inserts overview

Negative angle





## Finishing







						
<b>CCMT-HF</b>	<b>DCMT-HF</b>	<b>SCMT-HF</b>	<b>TCMT-HF</b>	<b>VCMT-HF</b>	<b>CPMT-HF</b>	<b>DPMT-HF</b>
Length of cutting edge	06,09,12	07,09	09	06,09,11,16	11	06,09
Page	A48	A50	A52	A55	A57	A59



		
<b>SPMT-HF</b>	<b>TPMT-HF</b>	<b>VBMT-HF</b>
Length of cutting edge	09	09,11
Page	A61	A62

Positive angle



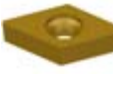

## Aluminium machining

				
<b>CCGX-AC</b>	<b>DCGX-AC</b>	<b>SCGX-AC</b>	<b>TCGX-AC</b>	<b>VCGX-AC</b>
Length of cutting edge	06,09,12	07,11	09,12	09,11,16
Page	A49	A51	A53	A56

						
<b>CCGW</b>	<b>DCGW</b>	<b>SCGW</b>	<b>TCGW</b>	<b>VCGW</b>	<b>CPGW</b>	<b>DPGW</b>
Length of cutting edge	06,09,12	07,11	09,12	11,16	11	06
Page	A49	A51	A53	A56	A57	A59

		
<b>SPGW</b>	<b>TPGW</b>	<b>VBGW</b>
Length of cutting edge	09,12	09,11,16,22
Page	A61	A62

## Parting and grooving inserts

			
<b>QDMA□□□□N</b>	<b>QCMB□□□□N-GM</b>	<b>QFMB□□□□NK-GM</b>	<b>QCMB-MT</b>
Width	3,12~9,85	2,3,4,5,6	5
Page	A158	A159	A160

# Turning Turning inserts overview

A

Common turning

Turning inserts overview

## Threading inserts

The illustration shows Right toolholder

	Partial profile 60°		Partial profile 55°		ISO Metric	
	External thread	Internal thread	External thread	Internal thread	External thread	Internal thread
Pitch/Tooth No.	0.5~6.0	0.5~6.0	0.5~6.0	0.5~6.0	0.35~6.0	0.35~6.0
Page	A189	A189	A190	A190	A191	A193

The illustration shows Right toolholder

	American UN		Whitworth		British Standard Pipe thread	
	External thread	Internal thread	External thread	Internal thread	External thread	Internal thread
Pitch/Tooth No.	72~4	72~4	72~4	72~4	28~11	28~11
Page	A195	A197	A199	A201	A203	A203

The illustration shows Right toolholder

	American 60° NPTape pipe thread		National Pipe Threads-Dryseal		Round DIN 405	
	External thread	Internal thread	External thread	Internal thread	External thread	Internal thread
Pitch/Tooth No.	27~8	27~8	27~8	27~8	10~4	10~4
Page	A204	A204	A205	A205	A206	A206

The illustration shows Right toolholder

	Trapez DIN 103		American ACME	
	External thread	Internal thread	External thread	Internal thread
Pitch/Tooth No.	1.5~6.0	1.5~6.0	16~4	16~4
Page	A207	A207	A208	A208



# Recommended grade overview for turning inserts **Turning**

**A**

Common turning

Recommended grade overview for turning inserts

ISO	Common turning				Thread	Parting and grooving				
	Code	Coated		Cemented carbide		Coated	Coated	Cemented carbide		
		CVD	PVD			PVD	CVD		PVD	
<b>P</b> Steel	01							JT4125 JT4225		
	10	JT4015		JT1015	JP302				JT1225	
	20	JT4025	JT4115	JT1025	JP402	JT1025	JT1225	JT4025	JT1025	
	30	JT4035	JT4125	JT1035	JPP302	JT1225				
	40	JT4135	JT4215	JT1225	JPP402					
<b>M</b> Stainless steel	01			JT1005		JT1225			JT1225	
	10	JT4330		JT1015						
	20	JT4340		JT1025		JT1025				
	30	JT4350		JT1035					JT1025	
	40			JT1235						
<b>K</b> Cast iron	01	JT3105			JK002					
	10	JT3115			JK102					
	20	JT3125	JT3205		JK202	JT1025			JT1025	JK202
	30		JT3215							
	40		JT3225							
<b>N</b> Non-ferrous metal	01									
	10				JK102	JT1025				JK202
	20									
	30									
<b>S</b> Heat resistant alloy titanium alloy	01			JT1015						
	10			JT1025	JK102	JT1025		JT1025		JK202
	20									
	30									
<b>H</b> High hardness material	01									
	10									
	20									
	30									

# Turning

## Common turning inserts

Introduction of chipbreaker	A13-A14
Processing application note	A15-A22
Common turning inserts	A24-A62
Common turning inserts naming rules	A24-A25
Cemented carbide inserts	A26-A62
List of negative inserts	A26-A46
List of positive inserts	A47-A62

### Negative inserts with holes

Introduction of chipbreaker





Use	Chipbreaker	Tolerance	Accuracy Recommended	Feature/Shape
Roughing	GR Double-side	M	ap=3~12(mm) fn=0.3~0.8(mm/r)	For P & K type light load roughing M class double chip breaker, metal removal rate and edge economy can have it all. 
	GR One-side	M	ap=3~15(mm) fn=0.3~0.8 (mm/r)	For P type roughing M class single chip breaker, high safety, edge in high cutting depth, high cutting feed can obtain high metal removal rate and low cutting force. 
	BR	M	ap=2.5~8(mm) fn=0.2~0.6(mm/r)	For M type roughing M class double chip breaker, strong impact resistance, groove type design made the best balance between safety and sharp edge, solved the big cutting-heat, stick knives and other difficulties in the process of roughing of stainless steel, obtained the high efficiency. 
	KR	M	ap=5~15(mm) fn= 0.3~1.0(mm/r)	For K type heavy load machining M class double chip breaker, tough edge, with a high security, strong ability to resist plastic deformation at high removal rate. 
	Semi-finishing	GS	M	ap=1.5~5(mm) fn=0.15~0.5(mm/r)
GM		M	ap=1.5~5(mm) fn=0.15~0.5(mm/r)	For P type Semi-finishing M class double chip breaker, edge is stronger than GS, suitable for Semi-finishing at unstable condition, cast iron processing, lower cutting force. 
BM		M	ap=0.5~1.5(mm) fn=0.1~0.3(mm/r)	For M type Semi-finishing M class double chip breaker, effectively solve the processing difficulty, such as stainless steel breaking chip, stick knife, obtain higher processing efficiency than BF. 
Straight slot		M	ap=1.5~5(mm) fn=0.2~0.5(mm/r)	For P,M&K type Semi-finishing to roughing M class double chip breaker, edge tough, good versatility. 
Finishing		GF	M	ap=0.3~2(mm) fn=0.05~0.35(mm/r)
	BF	M	ap=0.05~1(mm) fn=0.05~0.3 (mm/r)	For M type Finishing M class double chipbreaker, a sharp edge, effectively solve the processing difficulty, such as stainless steel breaking chip, stick knife, surface hardening, get high quality. 

BavandAbzar.com

# Turning

## Common turning Introduction of grooving inserts

### Negative insert with hole

Use	Chipbreaker	Tolerance	Accuracy Recommended	Feature/Shape
Roughing	HR	M	ap=3~7(mm) fn=0.3~0.7(mm/r)	For roughing M class tolerance, suitable for internal and external roughing of steel, stainless steel and cast iron materials. 
Semi-Finishing	HM	M	ap=1~4(mm) fn=0.2~0.5(mm/r)	For semi-finishing M class tolerance, suitable for internal and external semi-finishing of steel and cast iron materials. 
Finishing	HF	G	ap=0.1~2(mm) fn=0.05~0.3 (mm/r)	For finishing M class tolerance, suitable for internal and external semi-finishing of steel and cast iron materials. 
Aluminium alloy machining	AC	G	ap=0.02~4.8(mm) fn=0.05~0.5(mm/r)	For Aluminum machining G class tolerance, big rake angle and clearance angle make more sharp edge, cutting lighter under the condition of ensure effective chip breaker. 

Introduction of grooving

## Common turning processing Processing application note

# Turning

### Main scope of prove type of chipbreaker

#### Negative inserts

Processing application note

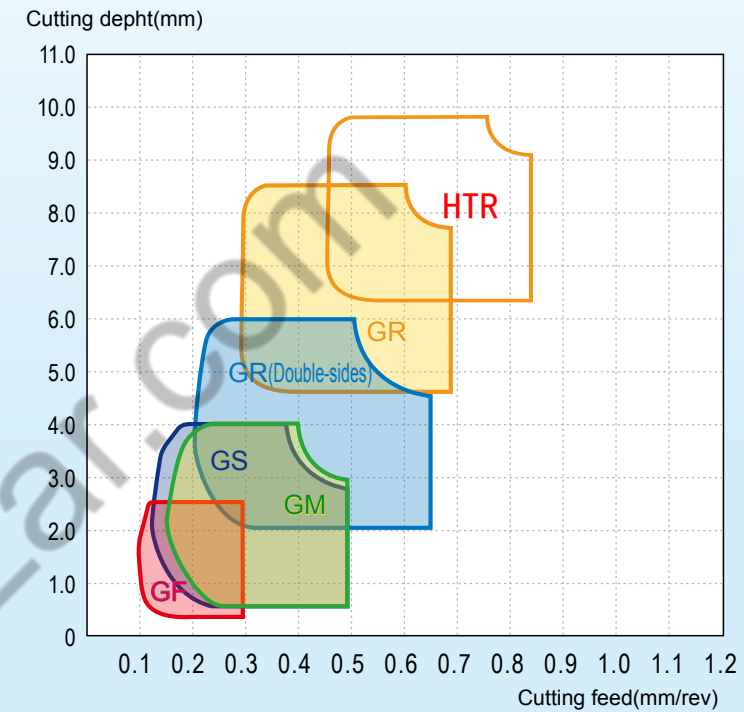

◆ Material:45#steel

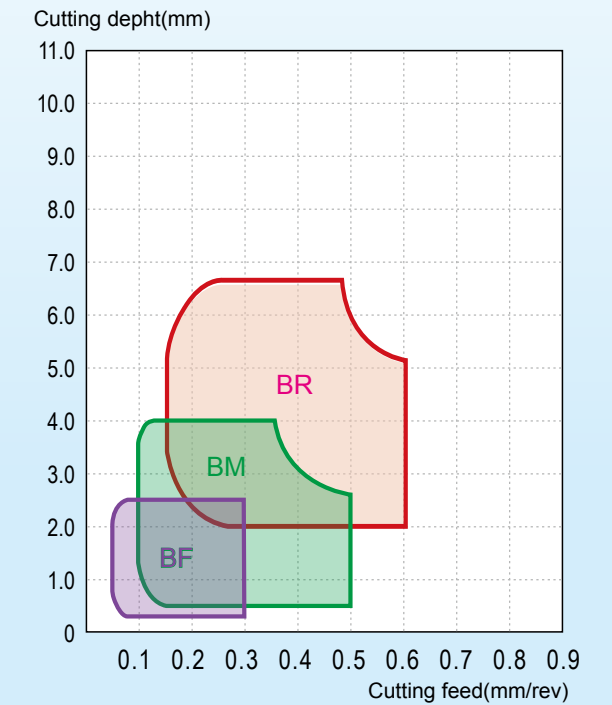

◆ Material:stainless steel(1Cr18Ni9Ti)

#### Positive inserts

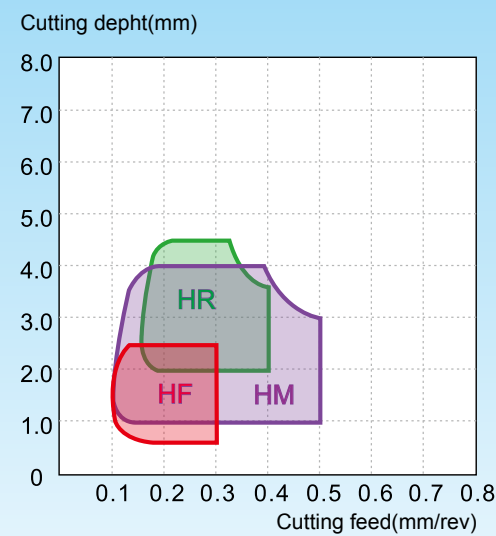

◆ Material:45#steel

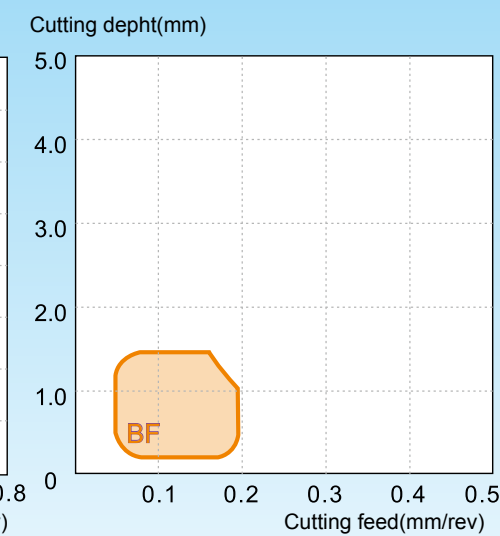

◆ Material:stainless steel(1Cr18Ni9Ti)

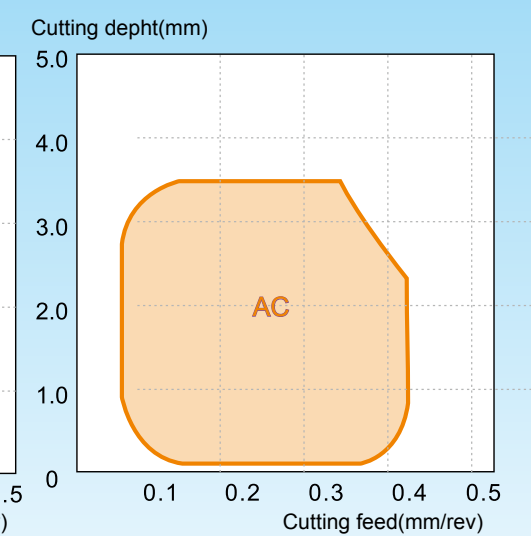

◆ Material: aluminum alloy



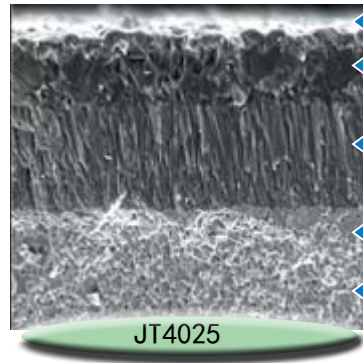

- Surface gold TiN has the excellency of reducing the friction and wear recognition effect.
- Special structure of Al<sub>2</sub>O<sub>3</sub> settled layer has the best thermal barrier performance, high speed dry cutting, ensure resistance to plastic deformation of blade matrix at high speed dry cutting.
- TiCN layer with anti-wear material abrasion performance lead to the best wear resistant of the face of clearance angle.
- Using gradient sintering technology, and increase the impact resistance and wear resistance of insert, so as to improve the ability to resist damage of the insert.
- Carbide with special crystal structure improves the red hardness of the blade matrix, and strengthened the high temperature resistant performance of insert.

### JT4015

High wear-resistant substrates combine with MT-TiCN,thick Al<sub>2</sub>O<sub>3</sub>,TiN coatings,excellent grades of steel,cast steel & stainless steel materials' finish processing at high speed cutting conditions.

### JT4025

Special strength & toughness of the blade's substrates,perfect combinations with MT-TiCN,thick Al<sub>2</sub>O<sub>3</sub>, TiN coating,common grades for steel,suitable for steel,cast steel & stainless steel in semi-finishing,finishing.

### JT4035

High-strength resistance & antiplastic deformation substrates,combining with MT-TiCN,thick Al<sub>2</sub>O<sub>3</sub>, TiN coating,good toughness & anti-plastic deformation,suitable for steel,cast steel & stainless steel in light-roughing & roughing.

### JT4330

High hardness substrates,medium and high speed, suitable for light & heavy milling of low alloy steel & unalloyed steel,also suitable for milling at low condition.

### JT4340

Wear-resistant & good toughness substrates, common coating cemented carbide grades, used for medium and low speed milling of steel, cast iron, hardened steel.

### JT4350

Good toughness & wear-resistant substrates, perfect combinations with MT-TiCN, superfine Al<sub>2</sub>O<sub>3</sub>, common coating cemented carbide grades, used for medium and low speed milling of steel, cast iron, hardened steel.

### JT3105

Coatings & tough substrates combination,supporting high-temperature & unplastic-deformation,suitable for ductile cast iron,forged cast-iron with high strength,ferrosteel in finishing & semi-finishing.

### JT3115

High wear-resistant substrates,perfect combinations with MTTi(CN),thick Al<sub>2</sub>O<sub>3</sub> coating,initial grades for ductile cast iron,forged cast iron,highly cutting speed allowance.

### JT3125

Wear-resistant & good toughness substrates,perfect combinations with MT-Ti(CN), thick Al<sub>2</sub>O<sub>3</sub> coating,initial grades for ductile cast iron & forged cast iron in roughing & highly-metal.

### JT4115

High wear resistant substrates combine with MT-TiCN, thick Al<sub>2</sub>O<sub>3</sub> coatings,excellent grades of steel,cast steel & stainless steel materials' finish processing at high-speed cutting conditions.

### JT4125

Special strength & toughness of the insert substrates,perfect combinations with MT-TiCN, ultra fine Al<sub>2</sub>O<sub>3</sub> coatings,common grades for steel,suitable for steel,cast steel & stainless steel in semi-finishing,finishing.

### JT4135

High-strength resistance & antiplastic deformation substrates,combining with MT-TiCN, ultra fine Al<sub>2</sub>O<sub>3</sub>, coatings,good toughness & anti-plastic deformation,suitable for steel,cast steel & stainless steel in light-roughing & roughing.

## Higher cutting speed and longer life of insert Black general insert

*The second generation of steel processing*

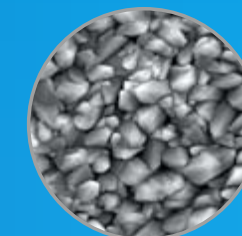

Before the surface treatment

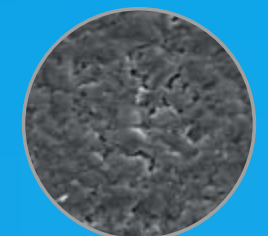

After the surface treatment

The inserts with special surface technology, greatly improved the surface roughness, effectively reduce the cutting force, reduce the adhesive between the cutter surface and the processed material, greatly improve the stability of inserts to use.

Fibrous TiCN and the perfect combination of fine grain Al<sub>2</sub>O<sub>3</sub> coating significantly improved the wear resistance and resistance to collapse of insert.

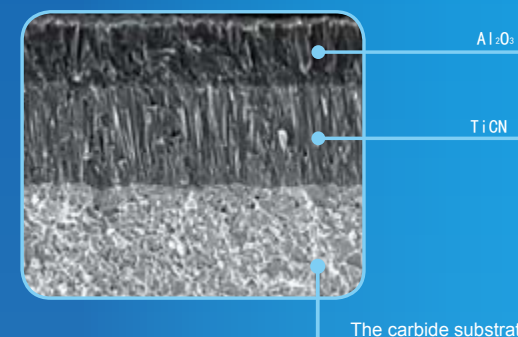

### Contrast effect of insert abrasion test

Workpiece(42CrMo Type:CNMG120408-GS Cutting parameter:Vc=390m/min ap=1.5mm fn=0.2mm/r

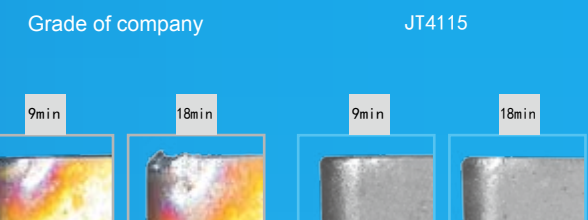

## Black general insert

First choice for high-speed and efficient processing of cast iron

● Thick  $Al_2O_3$  coating combined with strong impact resistance matrix, the insert has the stable high temperature red hardness and good impact resistance, improves the wear resistance of the insert under the requirement of high speed, high feed machining cast iron.

● All black product color shows more high-end

### Remarkable result

- Improve the production efficiency, coating and substrate are all adapted to cast iron of high speed and high feed cutting. **Cutting speed can be increased by 30% - 40%.**
- Reduce the cost, **improve the tool life of nearly 40% to 50%.**
- High stability of processing

### JT3205

Coatings & tough substrates combination, supporting high temperature & unelastic deformation, suitable for ductile cast iron, forged cast iron with high strength, ferosteel in finishing & semi-finishing.

### JT3215

High wear-resistant substrates, perfect combinations with MT-Ti(CN), ultra  $Al_2O_3$ , TiN coatings, initial grades for ductile cast iron, forged cast iron, highly cutting speed allowance

### JT3225

Wear-resistant & good toughness substrates, perfect combinations with MT-Ti(CN), ultra  $Al_2O_3$ , TiN coatings, initial grades for ductile cast iron & forged cast iron in roughing & highly-metal.

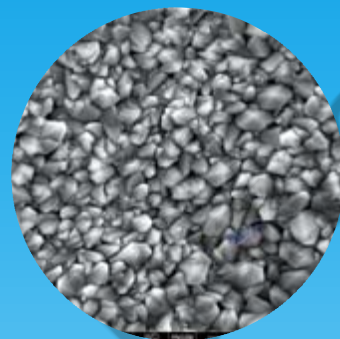

Density fine grain layer of surface

CVD Coated cemented carbide

### Recommended group of grade and groove type

P type machine		M type machine		K type machine	
Grade	Groove type	Grade	Groove type	Grade	Groove type
JT4025 JT4125 JT4225	GR(double-side)	JT4350 JT1035 JT1235	BR	JT3105 JT3205 JT3115 JT3215	KR
JT4035 JT4135 JT4235	GR(one-side)	JT4340 JT1025 JT1225	BM	JT3125 JT3225	Slotless
JT4025 JT4125 JT4225	GS, GM	JT4330 JT1015 JT1215	BF		
JT4015 JT4115 JT4215	GF				

### Recommended cutting condition

Workpiece	Machine range	Grade	Recommended cutting speed (m/min)
P Steel	Finishing	JT4015	170-450
		JT4115	210-460
	Semi-Finishing	JT4025 JT4215	150-420
		JT4125 JT4225	170-460
	Roughing	JT4035 JT4135 JT4235	120-360
M Stainless steel	Finishing	JT4330 JT1215	100-270
		JT4340 JT1225	
	Semi-Finishing	JT4350 JT1235	
	Roughing		
K Cast iron	Finishing	JT3105	200-480
		JT3205	210-500
	Semi-Finishing	JT3115	160-430
		JT3215	180-430
	Roughing	JT3125 JT3225	130-360

### Machining examples

Insert for use	Type	CNMG120408-GM	CNMG190616-BR	TNMA220412
	Grade	JT4125	JT4340	JT3105
Shape				
Material&Hardness		42CrMo HB280	1Cr13 HB270	Ferosteel HB280
condition	parameters	$V=240\text{m/min}$ $a_p=1.5\sim 2\text{mm}$ $f=0.2\text{mm/r}$	$V=100\text{m/min}$ $a_p=1.5\sim 3.0\text{mm}$ $f=0.3\text{mm/r}$	$V_{\text{max}}=400\text{m/min}$ $a_p=1.3\sim 2.5\text{mm}$ $f=0.4\sim 1.1\text{mm/r}$
	type	Dry cutting	Dry cutting	Dry cutting
Contrast				
		JT4125 Company A Machine part No. (piece)/edge	JT4340 Company A Machine part No. (piece)/edge	JT3105 Company A Machine part No. (piece)/edge

## JT4215

High wear-resistant substrates, combinations with MT-TiCN, superfine Al<sub>2</sub>O<sub>3</sub>, TiN coating; excellent grades of steel, cast steel & stainless steel materials' finish processing at high-speed cutting conditions.

## JT4225

Special strength & toughness of the insert substrates, perfect combinations with MT-TiCN, superfine Al<sub>2</sub>O<sub>3</sub>, TiN coating; common grades for steel, suitable for steel, cast steel & stainless steel in semi-finishing, finishing, etc.

## JT4235

High-strength resistance & antiplastic deformation substrates, combining with MT-TiCN, superfine Al<sub>2</sub>O<sub>3</sub>, TiN coatings, good toughness & anti-plastic deformation, suitable for steel, cast steel & stainless steel in light-roughing & roughing.

## JT4240

Wear-resistant & good toughness substrates, common coating cemented carbide grades, used for medium and low speed milling of steel, cast iron, hardened steel.

## JT4250

Excellent toughness substrates, Suitable for medium and heavy milling of steel & cast stainless steel.

## JT3205

Coatings & tough substrates combination, supporting high-temperature & unplastic-deformation, suitable for ductile cast iron, forged cast-iron with high strength, ferrosteel in finishing & semi-finishing.

## JT3215

High wear-resistant substrates, perfect combinations with MT-TiCN, superfine Al<sub>2</sub>O<sub>3</sub>, TiN coating; initial grades for ductile cast iron, forged cast iron, highly cutting speed allowance.

## JT3225

Wear-resistant & good toughness substrates, perfect combinations with MT-Ti(CN), superfine Al<sub>2</sub>O<sub>3</sub>, TiN coating; initial grades for ductile cast iron & forged cast iron in roughing & highly-metal.

## JT3220

Wear-resistant & good toughness substrates, perfect combinations with Thin MT-Ti(CN), superfine Al<sub>2</sub>O<sub>3</sub>, TiN coating; initial grades for ductile cast iron & forged cast iron in roughing & highly-metal.

## JT3240

Wear-resistant & good toughness substrates, common coating cemented carbide grades, used for medium and low speed milling of steel, cast iron, hardened steel.

## JT4015

High wear-resistant substrates, combinations with MT-TiCN, thick Al<sub>2</sub>O<sub>3</sub>, TiN coating; excellent grades of steel, cast steel & stainless steel materials' finish processing at high-speed cutting conditions.

## JT4025

Special strength & toughness of the insert substrates, perfect combinations with MT-TiCN, thick Al<sub>2</sub>O<sub>3</sub>, TiN coating; common grades for steel, suitable for steel, cast steel & stainless steel in semi-finishing, finishing.

## JT4035

High-strength resistance & antiplastic deformation substrates, combining with MT-TiCN, thick Al<sub>2</sub>O<sub>3</sub>, TiN coatings, good toughness & anti-plastic deformation, suitable for steel, cast steel & stainless steel in light-roughing & roughing.

## JT3005

Coating & tough substrates combination, supporting high temperature & unplastic deformation. Suitable for ductile cast iron, forged cast iron with high strength, ferrosteel in finishing & semi-finishing.

## JT3015

High wear-resistant substrates, combinations with MT-TiCN, thick Al<sub>2</sub>O<sub>3</sub>, TiN coating; initial grades for ductile cast iron, forged cast iron, highly cutting speed allowance.

## JT3025

Wear-resistant & good toughness substrates, perfect combinations with MT-Ti(CN), thick Al<sub>2</sub>O<sub>3</sub>, TiN coating; initial grades for ductile cast iron & forged cast iron in roughing & highly-metal.

## JT4030

High hardness substrates, medium and high speed; suitable for light & heavy milling of low alloy steel & unalloyed steel, also suitable for milling at low condition.

## JT4040

Wear-resistant & good toughness substrates, common coating cemented carbide grades, used for medium and low speed milling of steel, cast iron, hardened steel.

## JT4050

Excellent toughness substrates, suitable for medium and heavy milling of steel & cast stainless steel.

CVD Coated cemented carbide

CVD Coated cemented carbide



# PVD coated cemented carbide

Let the difficult machining materials gets easy

## New grade of nano coated

- Special coating process lead to smooth surface, low cutting resistance force and easy chip-flow.
- Unique nano structure coating, closer integration with the substrate, towards higher toughness and hardness.
- Good thermal stability and chemical stability of cutting edges provide more effective protection.

High performance TiAlN coated of nano structure ensures that the insert has a very high toughness and hardness. Unique coating technology makes the insert with smooth surface and high wear resistance, excellent thermal stability and chemical stability provide effective protection of cutting edge

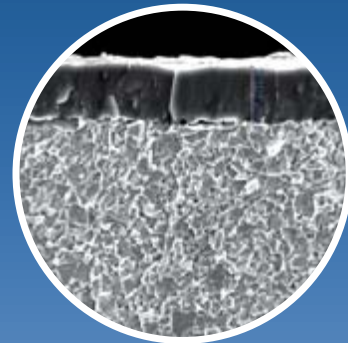

nc-TiAlN Coating(JT1025)

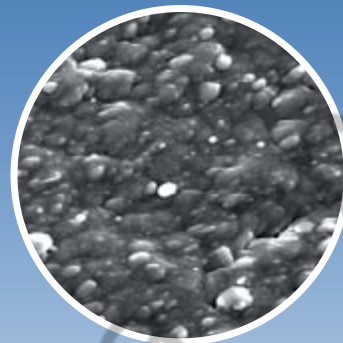

The coating surface of JT1025

### JT1015

2-4 $\mu$ m TiAlN PVD coated, combining with fine particles' substrates with high-toughness, suitable for all materials, high-temperature alloy & Ti alloy in finishing, semi-finishing.

### JT1025

2-4 $\mu$ m TiAlN PVD coated, combining with ultra fine particles' substrates with high-toughness, suitable for all materials, stainless steel & high-temperature alloy in finishing, semi-finishing.

### JT1035

PVD coated, combining with high-resistant substrates, suitable for all materials in roughing, semi-finishing.

### JT1215

3-5 $\mu$ m TiAlN+TiAlSiN PVD Coated, high wear resistance, high oxidation resistance, combined with fine particle's substrates with excellent performance, suitable for light, medium load milling.

### JT1225

2-4 $\mu$ m AlCrN+AlCrSiN PVD coated, combining with ultra fine particles' substrates with high-toughness, suitable for all materials in light & medium load milling, stainless steel & high-temperature high hardness alloy in finishing, semi-finishing.

### JT1235

3-5 $\mu$ m TiAlN+TiAlSiN PVD Coated, high wear resistance, high oxidation resistance, combined with hard alloy with excellent toughness cemented carbide substrates, suitable for all kinds of processed materials with high hardness and medium load milling and drilling, stainless steel and high temperature alloy in semi-finishing, rough turning, cutting and grooving, achieving the combination of the perfect safety and wear resistance.

# PVD Coated cemented carbide

## Recommended group of grade and slot type

### P type machine

Grade Groove type

- JT1035  
JT1235 GR
- JT1025  
JT1225 GM
- JT1015  
JT1005  
JT1215  
JT1205 GF

### M type machine



Grade Groove type

- JT1235  
JT1035  
JT4350 BR
- JT1225  
JT1025  
JT4340 BM
- JT1015  
JT4330  
JT1215 BF

## Recommended cutting condition

Workpiece	Machine range	Grade	Recommended cutting speed(m/min)	
P	Steel	Semi-Finishing	JT1025 JT1225	160-360
		Roughing	JT1035 JT4350 JT1235	80-100
M	Stainless steel	Semi-Finishing	JT1025 JT4340 JT1225	120-240
		Finishing	JT1015 JT4330 JT1215	150-280

## Processing case

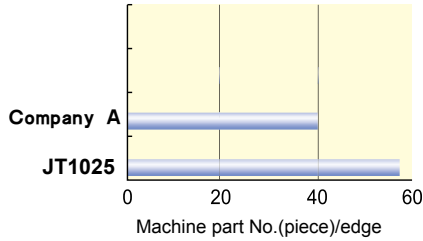
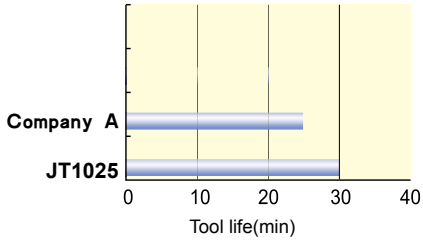
Insert for use	Type	CNMG120404-GM	DNMG150404-BM
	Grade	JT1025	JT1025
Shape			
Material&Hardness		40Cr HB280	1Cr18Ni9Ti HB240
condition	parameter	V=220m/min ap=2.0mm f=0.15mm/r	Vc=150m/min ap=1.0mm f=0.15mm/r
	type	Dry cutting	Dry cutting
Performance			

## JPP302

Excellent toughness substrates and ALTiN PVD coated, Suitable for medium and heavy milling of steel & cast stainless steel.

## JPP402

Excellent toughness substrates and ALTiN PVD coated, Suitable for strong cutting steel, cast steel, should be used in low-speed and high feed processing under harsh conditions.

BavandAbzar.com

PVD Coated cemented carbide

# Grades of cemented carbide

Uncoated carbide grades are widely used in non-ferrous metal, high temperature alloys and other materials processing, manifests the versatility and efficiency in application.

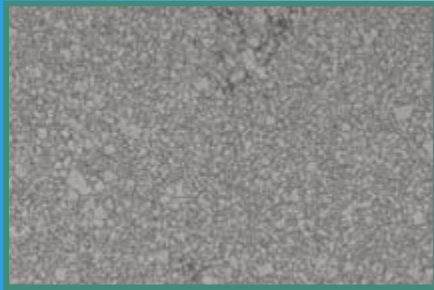

JT002 substrate - The combination of fine grain WC hard phase and binder phase Co.

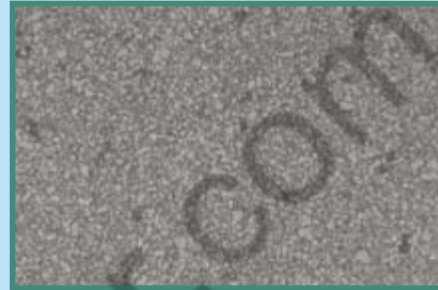

JK202 substrate, the combination of medium grain WC hard phase and binder phase Co.

## JP302

Suitable for finishing and semi-finishing steel, cast steel, appropriate uses high cutting speed and medium, small feed, and suitable for profile turning.

## JP402

For strong cutting steel, cast steel, should be used in low-speed and high feed processing under harsh conditions.

## JK002

Suitable for finishing and semi-finishing steel, cast steel, appropriate uses high cutting speed and medium, small feed.

## JK202

Used for semi-finishing of cast iron, heat resistant alloy, also used in plastic, rubber, wood and other non-metallic materials processing. Especially suitable for the aviation industry which has a sharp edge requirements. Appropriate use medium cutting speed and higher feed. Has good abrasion resistance and toughness.

## JK001

Suitable for finishing, semi-finishing cast iron, nonferrous metals, especially aluminum, and processing manganese steel, hardened steel and other hard materials.

### Recommended cutting condition

Workpiece		Machine range	Grade	Recommended cutting speed (m/min)
P Steel		Semi-finishing	JP302	120-300
		Roughing	JP402	90-280
K Cast iron		Finishing	JK002	110-160
		Semi-finishing to Roughing	JK202	70-120
N Nonferrous metal		Finishing to Semi-finishing	JK001	120-1800



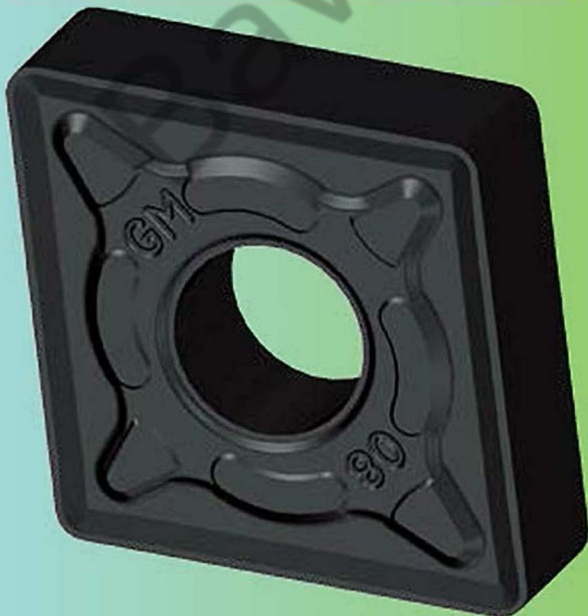
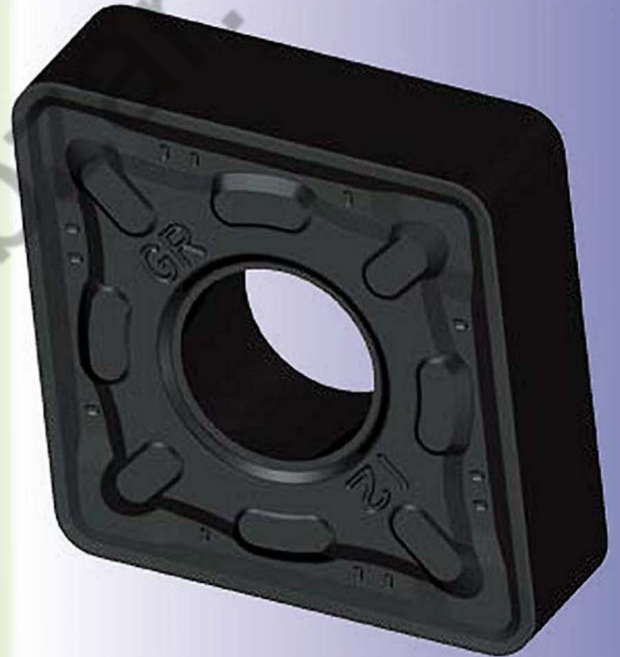
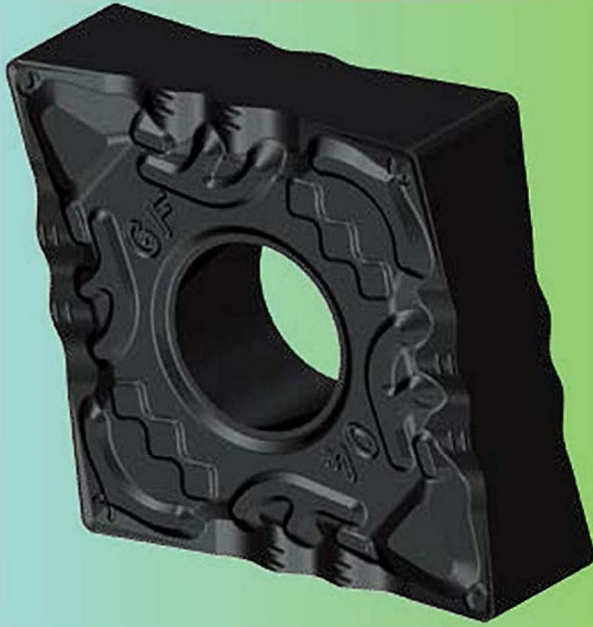

vandAb.com

Shape/Code			Metric				
Code	With/Without hole	With/Without	Section plane	Code	With/Without hole	Chipbreaker	Section plane
				<b>B</b>	With	Without	
				<b>H</b>	With	One-side	
				<b>C</b>	With	Without	
				<b>J</b>	With	Double-side	
				<b>W</b>	With	Without	
				<b>T</b>	With	One-side	
				<b>Q</b>	With	Without	
				<b>U</b>	With	Double-side	

**C N M G**

Clearance angle of main cutting edge			
Code	Clearance angle	Code	Clearance angle
<b>A</b>		<b>B</b>	
<b>C</b>		<b>D</b>	
<b>E</b>		<b>F</b>	
<b>G</b>		<b>N</b>	
<b>P</b>		<b>O</b>	Others

Tolerance										
Code	Nose height M tolerance(mm)	Tolerance of I.C.(mm)	Thickness S tolerance(mm)	(Reference) Details of M-class tolerance (Identified by shape and size)						
				● Nose height tolerance(mm)						
				Inscribed circle	Regular triangle	Square	Diamond with 80°	Diamond with 55°	Diamond with 35°	Round
<b>A</b>	±0.005	±0.025	±0.025	6.35	±0.08	±0.08	±0.08	±0.11	±0.16	---
<b>F</b>	±0.005	±0.013	±0.025	9.525	±0.08	±0.08	±0.08	±0.11	±0.16	---
<b>C</b>	±0.013	±0.025	±0.025	12.7	±0.13	±0.13	±0.13	±0.15	---	---
<b>H</b>	±0.013	±0.013	±0.025	15.875	±0.15	±0.15	±0.15	±0.18	---	---
<b>E</b>	±0.025	±0.025	±0.025	19.05	±0.15	±0.15	±0.15	±0.18	---	---
<b>G</b>	±0.025	±0.025	±0.13	25.4	---	±0.18	---	---	---	---
<b>J</b>	±0.005	±0.05±0.13	±0.025	● Tolerance of inscribed circle(mm)						
<b>K</b>	±0.013	±0.05±0.13	±0.025	Inscribed circle	Regular triangle	Square	Diamond with 80°	Diamond with 55°	Diamond with 35°	Round
<b>L</b>	±0.025	±0.05±0.13	±0.025	6.35	±0.05	±0.05	±0.05	±0.05	±0.05	---
<b>M</b>	±0.08±0.18	±0.05±0.13	±0.13	9.525	±0.05	±0.05	±0.05	±0.05	±0.05	±0.05
<b>N</b>	±0.08±0.18	±0.05±0.13	±0.025	12.7	±0.08	±0.08	±0.08	±0.08	---	±0.08
<b>U</b>	±0.13±0.38	±0.08±0.25	±0.13	15.875	±0.10	±0.10	±0.10	±0.10	---	±0.10
				19.05	±0.10	±0.10	±0.10	±0.10	---	±0.10
				25.4	---	±0.13	---	---	---	±0.13

Diameter of I.C.(mm)	Shape							
	C	D	R	S	T	V	W	K
3.97					06			
5.0			05					
5.56					09			
6.0			06					
6.35	06	07			11	11		
8.0			08					
9.525	09	11	09	09	16	16	06	16
10.0			10					
12.0			12					
12.7	12	15	12	12	22	22	08	
15.875	16		15	15	27			
16.0		19	16					
19.05	19		19	19	33			
20.0			20					
25.0	25	25	25					
25.4			25	25				
31.75			31					
32			32					

Code	Insert thickness(mm)
<b>00</b>	0.79
<b>T0</b>	0.99
<b>01</b>	1.59
<b>T1</b>	1.98
<b>02</b>	2.38
<b>T2</b>	2.58
<b>03</b>	3.18
<b>T3</b>	3.97
<b>04</b>	4.76
<b>T4</b>	4.96
<b>05</b>	5.96
<b>T5</b>	5.56
<b>06</b>	6.35
<b>T6</b>	6.75
<b>07</b>	7.94
<b>09</b>	9.52
<b>T9</b>	9.72
<b>11</b>	11.11
<b>12</b>	12.70

**12 04 08 - BM (ISO)**  
**4 3 2 (inch)**

Inscribed circle		Thickness		Nose radius		Nose radius code		Chipbreaker code		
Code	Diameter of I.C.(mm)	Code	Thickness	Code	Nose radius	Code	Nose radius	<b>GF</b>	<b>GM</b>	<b>GR</b>
2	6.35	2	3.18	0	0.2	00	No radius			
3	9.525	3	4.76	1	0.4	02	0.2			
4	12.7	4	6.35	2	0.8	04	0.4			
5	15.875	5	7.94	3	1.2	08	0.8			
6	19.05	6	9.52	4	1.6	12	1.2			
8	25.4			5	2.0	16	1.6			
				6	2.4	20	2.0			
						24	2.4			
						32	3.2			
						X	Round insert			





# Turning

## Common Turning Inserts

Cemented carbide insert

CN□□ (Negative)

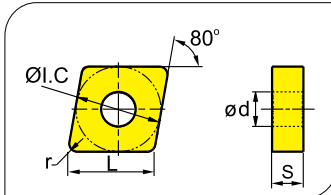

Shape	Type	Dimension(mm)					Coated cemented carbide															Cemented carbide								
		L	φ I.C	S	φ d	r	P					M					K					JP302	JP402	JK002	JK102	JK202				
							JT4015	JT4115	JT4025	JT4125	JT4035	JT4135	JT1015	JT1025	JT1035	JT1045	JT4330	JT4340	JT4350	JT3105	JT3205	JT3115	JT3215	JT3125	JT3225					
Slotless	CNMA120404	12.9	12.7	4.76	5.16	0.4		☆	☆											☆										☆
	CNMA120408	12.9	12.7	4.76	5.16	0.8		☆	☆											☆	★	○								☆
	CNMA120412	12.9	12.7	4.76	5.16	1.2		☆	☆													★	○							☆
	CNMA120416	12.9	12.7	4.76	5.16	1.6		☆	☆													★	○							☆
	CNMA160608	16.1	15.875	6.35	6.35	0.8					☆	☆										★	○							☆
	CNMA160612	16.1	15.875	6.35	6.35	1.2					☆	☆										★	○							☆
	CNMA160616	16.1	15.875	6.35	6.35	1.6					☆	☆										★	○							☆
	CNMA160620	16.1	15.875	6.35	6.35	2.0					☆	☆										☆	★							☆
	CNMA160630	16.1	15.875	6.35	6.35	3.0					☆	☆										☆	★							☆
	CNMA190612	19.3	19.05	6.35	7.94	1.2					☆	☆										★								☆
CNMA190616	19.3	19.05	6.35	7.94	1.6					☆	☆										☆	★							☆	
GM	CNMG090304-GM	9.7	9.525	3.18	3.81	0.4	○	☆	☆	★			☆							☆	★									
	CNMG090308-GM	9.7	9.525	3.18	3.81	0.8	○	☆	☆	★	○		☆							☆	★									
	CNMG120404-GM	12.9	12.7	4.76	5.16	0.4	○	☆	☆	★			☆							☆	★									
	CNMG120408-GM	12.9	12.7	4.76	5.16	0.8	○	☆	☆	★	○		☆							☆	★									
Semi-finishing	CNMG120412-GM	12.9	12.7	4.76	5.16	1.2	○	☆	☆	★	○		☆						☆	★										
GS	CNMG090304-GS	9.7	9.525	3.18	3.81	0.4	○	☆	☆	★										○	☆									
	CNMG090308-GS	9.7	9.525	3.18	3.81	0.8	○	☆	☆	★	○									○	☆									
	CNMG120404-GS	12.9	12.7	4.76	5.16	0.4	○	☆	☆	★										○	☆									
	CNMG120408-GS	12.9	12.7	4.76	5.16	0.8	○	☆	☆	★										○	☆									
Semi-finishing	CNMG120412-GS	12.9	12.7	4.76	5.16	1.2	○	☆	☆	★	○								○	☆										

★Recommended grade ☆Optional grade ○Make to order

Applicable tool



# Common Turning Inserts

Cemented carbide insert

# Turning

CN□□ (Negative)

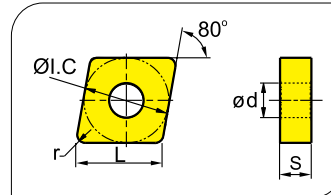

Shape	Type	Dimension(mm)					Coated cemented carbide															Cemented carbide								
		L	φ I.C	S	φ d	r	P					M					K					JP302	JP402	JK002	JK102	JK202				
							JT4015	JT4115	JT4025	JT4125	JT4035	JT4135	JT1015	JT1025	JT1035	JT1045	JT4330	JT4340	JT4350	JT3105	JT3205	JT3115	JT3215	JT3125	JT3225					
BM	CNMG090304-BM	9.7	9.525	3.18	3.81	0.4															○	★								
	CNMG090308-BM	9.7	9.525	3.18	3.81	0.8															○	★								
	CNMG120404-BM	12.9	12.7	4.76	5.16	0.4															○	★								
	CNMG120408-BM	12.9	12.7	4.76	5.16	0.8															○	★								
	CNMG120412-BM	12.9	12.7	4.76	5.16	1.2															○	★								
Semi-finishing	CNMG120412-BM	12.9	12.7	4.76	5.16	1.2														○	★									
GF	CNMG090304-GF	9.7	9.525	3.18	3.81	0.4	☆	★	○												○									
	CNMG090308-GF	9.7	9.525	3.18	3.81	0.8	☆	★	○												○									
	CNMG120404-GF	12.9	12.7	4.76	5.16	0.4	☆	★	○												○									
	CNMG120408-GF	12.9	12.7	4.76	5.16	0.8	☆	★	○												○									
Finishing	CNMG120412-GF	12.9	12.7	4.76	5.16	1.2	☆	★	○												○									
BF	CNMG090304-BF	9.7	9.525	3.18	3.81	0.4															○	★								
	CNMG090308-BF	9.7	9.525	3.18	3.81	0.8															○	★								
	CNMG120404-BF	12.9	12.7	4.76	5.16	0.4															○	★								
	CNMG120408-BF	12.9	12.7	4.76	5.16	0.8															○	★								
Finishing	CNMG120412-BF	12.9	12.7	4.76	5.16	1.2														○	★									

★Recommended grade ☆Optional grade ○Make to order

Applicable tool



# Turning

## Common Turning Inserts

Cemented carbide insert

CN □ □ (Negative)

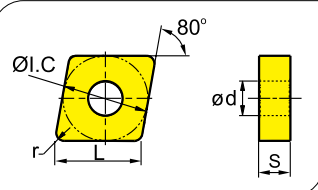

Shape	Type	Dimension(mm)						Coated cemented carbide														Cemented carbide								
		L	φ I.C	S	φ d	r	P						M						K		JP		JK							
							JT4015	JT4115	JT4025	JT4125	JT4035	JT4135	JT1015	JT1025	JT1035	JT1045	JT4330	JT4340	JT4350	JT3105	JT3205	JT3115	JT3215	JT3125	JT3225	JP302	JP402	JK002	JK102	JK202
GR	DNMG150408-GR	15.5	12.7	4.76	5.16	0.8			○	○	☆	★															☆			
	DNMG150412-GR	15.5	12.7	4.76	5.16	1.2			○	○	☆	★															☆			
	DNMG150416-GR	15.5	12.7	4.76	5.16	1.6			○	○	☆	★															☆			
	DNMG150608-GR	15.5	12.7	4.76	5.16	0.8			○	○	☆	★															☆			
	DNMG150612-GR	15.5	12.7	6.35	5.16	1.2			○	○	☆	★															☆			
Roughing	DNMG150616-GR	15.5	12.7	6.35	5.16	1.6			○	○	☆	★															☆			
	DNMM150608-GR	15.5	12.7	6.35	5.16	0.8			○	○	☆	★															☆			
	DNMM150612-GR	15.5	12.7	6.35	5.16	1.2			○	○	☆	★															☆			
Roughing	DNMM150616-GR	15.5	12.7	6.35	5.16	1.6			○	○	☆	★															☆			
	DNMG150608-BR	15.5	12.7	6.35	5.16	0.8								☆	★			○												
	DNMG150612-BR	15.5	12.7	6.35	5.16	1.2								☆	★			○												
Roughing	DNMG150616-BR	15.5	12.7	6.35	5.16	1.6								☆	★			○												
	DNMG150608-KR	15.5	12.7	6.35	5.16	0.8		○													☆	★								
	DNMG150612-KR	15.5	12.7	6.35	5.16	1.2		○													☆	★								
Straight slot	DNMG150604	15.5	12.7	6.35	5.16	0.4	○	☆	★	○										☆	★		○							
	DNMG150608	15.5	12.7	6.35	5.16	0.8	○	☆	★	○										☆	★		○							
	DNMG150612	15.5	12.7	6.35	5.16	1.2	○	☆	★	○										☆	★		○							
	DNMG150616	15.5	12.7	6.35	5.16	1.6	○	☆	★	○										☆	★		○							
	DNMG190608	19.3	15.875	6.35	7.94	0.8	○	☆	★	○										☆	★		○							
	DNMG190612	19.3	15.875	6.35	7.94	0.8	○	☆	★	○										☆	★		○							

★Recommended grade ☆Optional grade ○Make to order

Applicable tool



# Turning

## Common Turning Inserts

Cemented carbide insert

DN □ □ (Negative)

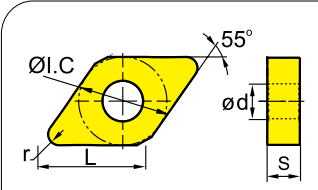

Shape	Type	Dimension(mm)						Coated cemented carbide														Cemented carbide									
		L	φ I.C	S	φ d	r	P						M						K		JP		JK								
							JT4015	JT4115	JT4025	JT4125	JT4035	JT4135	JT1015	JT1025	JT1035	JT1045	JT4330	JT4340	JT4350	JT3105	JT3205	JT3115	JT3215	JT3125	JT3225	JP302	JP402	JK002	JK102	JK202	
Slotless	DNMA110416	11.6	9.525	4.76	3.81	1.6	○	☆	★																					☆	
	DNMA110424	11.6	9.525	4.76	3.81	2.4	○	☆	★																					☆	
	DNMA150404	15.5	12.7	4.76	5.16	0.4	○	☆	★																					☆	
	DNMA150408	15.5	12.7	4.76	5.16	0.8			☆	★																				☆	
	DNMA150604	15.5	12.7	6.35	5.16	0.4			☆	★																				☆	
	DNMA150608	15.5	12.7	6.35	5.16	0.8			☆	★																				☆	
	DNMA150612	15.5	12.7	6.35	5.16	1.2			☆	★	○																		☆		
	DNMA150616	15.5	12.7	6.35	5.16	1.6			☆	★	○																		☆		
	GM	DNMG110404-GM	11.6	9.525	4.76	3.81	0.4	○	☆	★																					
		DNMG110408-GM	11.6	9.525	4.76	3.81	0.8	○	☆	★																					
DNMG110412-GM		11.6	9.525	4.76	3.81	1.2	○	☆	★																						
DNMG150404-GM		15.5	12.7	4.76	5.16	0.4	○	☆	★																						
DNMG150408-GM		15.5	12.7	4.76	5.16	0.8	○	☆	★																						
DNMG150412-GM		15.5	12.7	4.76	5.16	1.2	○	☆	★																						
Semi-finishing	DNMG150416-GM	15.5	12.7	4.76	5.16	1.6	○	☆	★																						
	DNMG150604-GM	15.5	12.7	6.35	5.16	0.4	○	☆	★																						
	DNMG150608-GM	15.5	12.7	6.35	5.16	0.8	○	☆	★																						
	DNMG150612-GM	15.5	12.7	6.35	5.16	1.2	○	☆	★																						

★Recommended grade ☆Optional grade ○Make to order

Applicable tool





SN□□ (Negative)

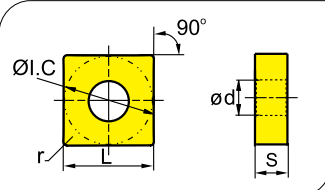

Shape	Type	Dimension(mm)					Coated cemented carbide															Cemented carbide						
							P					M					K											
		L	φ I.C	S	φ d	r	JT4015	JT4115	JT4025	JT4125	JT4035	JT4135	JT1015	JT1025	JT1035	JT1045	JT4330	JT4340	JT4350	JT3105	JT3205	JT3115	JT3215	JT3125	JT3225	JP302	JP402	JK002
GR	SNMG120408-GR	12.7	12.7	4.76	5.15	0.8		○	☆	★	☆		○															☆
	SNMG120412-GR	12.7	12.7	4.76	5.16	1.2		○	☆	★	☆		○															☆
	SNMG120416-GR	12.7	12.7	4.76	5.16	1.6		○	☆	★	☆		○															☆
	SNMG150608-GR	15.875	15.875	6.35	6.35	0.8		○	☆	★	☆		○															☆
	SNMG150612-GR	15.875	15.875	6.35	6.35	1.2		○	☆	★	☆		○															☆
	SNMG150616-GR	15.875	15.875	6.35	6.35	1.6		○	☆	★	☆		○															☆
	SNMG150624-GR	15.875	15.875	6.35	6.35	2.4		○	☆	★	☆		○															☆
	SNMG190612-GR	19.05	19.05	6.35	7.94	1.2		○	☆	★	☆		○															☆
	SNMG190616-GR	19.05	19.05	6.35	7.94	1.6		○	☆	★	☆		○															☆
	SNMG190624-GR	19.05	19.05	6.35	7.94	2.4		○	☆	★	☆		○															☆
Roughing	SNMM120408-GR	12.7	12.7	4.76	5.15	0.8		○	☆	★	☆		○															☆
	SNMM120412-GR	12.7	12.7	4.76	5.16	1.2		○	☆	★	☆		○															☆
	SNMM120416-GR	12.7	12.7	4.76	5.16	1.6		○	☆	★	☆		○															☆
	SNMM150608-GR	15.875	15.875	6.35	6.35	0.8		○	☆	★	☆		○															☆
	SNMM150612-GR	15.875	15.875	6.35	6.35	1.2		○	☆	★	☆		○															☆
	SNMM150616-GR	15.875	15.875	6.35	6.35	1.6		○	☆	★	☆		○															☆
	SNMM190608-GR	19.05	19.05	6.35	7.94	0.8		○	☆	★	☆		○															☆
	SNMM190612-GR	19.05	19.05	6.35	7.94	1.2		○	☆	★	☆		○															☆
	SNMM190616-GR	19.05	19.05	6.35	7.94	1.6		○	☆	★	☆		○															☆
	SNMM190624-GR	19.05	19.05	6.35	7.94	2.4		○	☆	★	☆		○															☆
Roughing	SNMM250724-GR	25.4	25.4	7.94	9.12	2.4		○	☆	★	☆		○															☆
	SNMM250924-GR	25.4	25.4	7.94	9.12	2.4		○	☆	★	☆		○															☆
	HTR SNMM250724-HTR	25.4	25.4	7.94	9.12	2.4																						
	HTR SNMM250924-HTR	25.4	25.4	7.94	9.12	2.4																						
	HTR SNMM250932-HTR	25.4	25.4	7.94	9.12	3.2																						
Roughing	HTR SNMM250932-HTR	25.4	25.4	7.94	9.12	3.2																						
	HTR SNMM190624-HTR	19.05	19.05	6.35	7.94	2.4																						

Applicable tool

★Recommended grade ☆Optional grade ○Make to order



SN□□ (Negative)

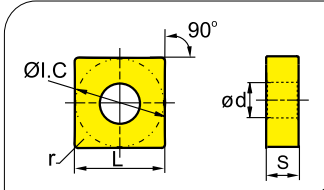

Shape	Type	Dimension(mm)					Coated cemented carbide															Cemented carbide							
							P					M					K												
		L	φ I.C	S	φ d	r	JT4015	JT4115	JT4025	JT4125	JT4035	JT4135	JT1015	JT1025	JT1035	JT1045	JT4330	JT4340	JT4350	JT3105	JT3205	JT3115	JT3215	JT3125	JT3225	JP302	JP402	JK002	JK102
BR	SNMG120408-BR	12.7	12.7	4.76	5.15	0.8																							
	SNMG120412-BR	12.7	12.7	4.76	5.15	1.2																							
	SNMG150608-BR	15.875	15.875	6.35	6.35	0.8																							
	SNMG150612-BR	15.875	15.875	6.35	6.35	1.2																							
	SNMG190612-BR	19.05	19.05	6.35	7.94	1.2																							
	SNMG190616-BR	19.05	19.05	6.35	7.94	1.6																							
Roughing	SNMG190616-BR	19.05	19.05	6.35	7.94	1.6																							
	SNMG120412-KR	12.7	12.7	4.76	5.16	1.2																							
	SNMG150608-KR	15.875	15.875	6.35	6.35	0.8																							
	SNMG150612-KR	15.875	15.875	6.35	6.35	1.2																							
	SNMM190612-KR	19.05	19.05	6.35	7.94	1.2																							
Straight slot	SNMG090304	9.525	9.525	3.18	3.81	0.4																							
	SNMG090308	9.525	9.525	3.18	3.81	0.8																							
	SNMG120404	12.7	12.7	4.76	5.16	0.4																							
	SNMG120408	12.7	12.7	4.76	5.16	0.8																							
	SNMG120412	12.7	12.7	4.76	5.16	1.2																							
	SNMG120416	12.7	12.7	4.76	5.16	1.6																							
	SNMG150608	15.875	15.875	6.35	6.35	0.8																							
	SNMG150612	15.875	15.875	6.35	6.35	1.2																							
	SNMG190612	19.05	19.05	6.35	7.94	1.2																							
	SNMG190616	19.05	19.05	6.35	7.94	1.6																							
	SNMG250724	25.4	25.4	7.94	9.12	2.4																							
	SNMG250924	25.4	25.4	7.94	9.525	2.4																							

★Recommended grade ☆Optional grade ○Make to order

Applicable tool







































1:CVD Add:JT4215/JT4225/JT4235

2:PVD Add:JT1015/JT1035/JT1215/JT1235

3:Cemented carbide Add:JPP302/JPP402

■ The common turning cutting dosage recommended list

ISO	Material	Hardness HB	CVD Coating					PVD Coating			Cemented carbide		
			JT4015	JT4025	JT4115	JT4125	JT4135	JT1025	JT1125	JT1225	JP302	JP402	
			Feed mm/rev										
			0.1-0.6	0.1-0.8	0.1-0.6	0.1-0.8	0.2-1.0	0.2-0.4	0.1-0.6	0.05-0.8	0.1-0.4	0.1-0.5	
Cutting speed m/min													
P	Carbon steel	C=0.15%	125	430-200	430-190	500-270	480-240	380-165	460-220	380-180	360-165	360-165	300-145
		C=0.35%	150	380-180	410-180	460-250	460-230	300-150	440-210	300-170	280-150	280-150	220-130
		C=0.60%	200	330-150	350-150	400-220	400-200	260-130	380-180	260-150	240-130	240-130	180-80
	Alloy steel	Anneal	180	350-170	350-150	400-180	400-200	200-100	380-180	200-120	180-100	180-100	160-80
		Harden	275	230-100	210-100	280-150	260-140	140-70	240-120	140-90	120-70	120-70	120-50
		Harden	300	210-100	190-70	260-150	240-120	125-60	220-100	125-80	100-60	100-60	80-40
	High alloy steel	Harden	350	180-80	170-70	230-120	220-120	110-55	200-100	110-75	90-55	90-55	70-45
		Anneal	200	320-150	260-120	360-190	310-170	175-80	290-150	175-100	155-80	155-80	135-60
	Cast iron	Harden	325	140-90	100-50	190-130	150-100	85-40	130-80	85-60	65-40	65-40	45-30
		Unalloy	180	240-120	200-100	280-160	250-140	135-75	230-125	135-95	115-75	115-75	95-55
		Low alloy	200	230-70	170-60	280-110	220-110	120-80	200-90	120-100	100-80	100-80	80-60
		High alloy	225	160-70	140-50	210-110	190-100	95-55	170-80	95-55	95-55	95-55	75-35
ISO	Material	Hardness HB	CVD Coating					PVD Coating					
			JT4330	JT4340	JT4350			JT1215	JT1225	JT1235			
			Feed mm/rev										
								0.1-0.4	0.2-0.4				
Cutting speed m/min													
M	Stainless steel	Ferrite	180	280-180	280-180					300-190	290-190		
		Austenite	260	250-150	250-150					250-160	240-160		
		Martensite	330	200-140	200-140					260-170	250-170		

■ The common turning cutting dosage recommended list

ISO	Material	Hardness HB	CVD Coating					Cemented carbide				
			JT3105	JT3205	JT3115	JT3215	JT3225	JK101	JK202			
			Feed mm/rev									
			0.1-0.4	0.1-0.6	0.1-0.4	0.1-0.5	0.1-0.8	0.1-0.3	0.1-0.4			
Cutting speed m/min												
K	Malleable cast iron	Ferrite	130	350-230	315-210	330-220	320-105	250-170	150-90	105-45		
		Pearlite	230	250-105	225-95	230-100	230-100	180-75	120-70	80-30		
	Low cast iron		180	520-200	450-180	480-200	480-190	380-150	170-100	130-60		
			260	230-120	210-110	220-115	210-100	170-90	130-70	95-40		
	Nodular cast iron	Ferrite	160	310-150	285-140	300-150	290-140	220-110	140-80	115-45		
		Pearlite	250	230-110	210-100	220-105	210-100	170-90	110-70	80-30		
ISO	Material	Hardness HB	Cemented carbide									
			JK002									
			Feed mm/rev									
			0.05-0.35									
Cutting speed m/min												
N	Aluminium alloy	Before heat treatment	60			1750-800						
		After heat treatment	100			510-250						
	Aluminium alloy (cast)	Before heat treatment	75			460-175						
		After heat treatment	90			300-110						
	Copper alloy	Lead alloy	110			610-205						
		Copper, pure copper	90			310-195						
	Copper, nonleaded copper electrolytic copper	100			225-115							

Common turning The common turning application data

Common turning The common turning application data

### The internal turning cutting parameter correction table

#### Internal turning tools by P type clamping

	Workpiece	Hardness	Processing form	L/D≤3		L/D=3-4 (Diameter of tool holder≥Φ16mm)	
				Feed(mm/rev)	Depth(mm)	Feed(mm/rev)	Depth(mm)
<b>P</b>	Carbon steel, alloy steel 45#, 42CrMo	HB180—280	Semi-finishing	0.1-0.25-0.4	<5.0	0.1-0.2-0.3	<4.0
<b>M</b>	Stainless steel 1Cr18Ni9Ti, 0Cr18Ni9	≤HB220	Semi-finishing	0.1-0.2-0.3	<4.0	0.1-0.15-0.25	<3.0
<b>K</b>	Cast iron HT250	HB170—230	Semi-finishing	0.1-0.25-0.4	<5.0	0.1-0.2-0.3	<4.0

#### Internal turning tools by S type clamping

	Workpiece	Hardness	Processing form	L/D≤3		L/D=4		L/D=5		L/D=6	
				Feed (mm/rev)	Depth (mm)	Feed (mm/rev)	Depth (mm)	Feed (mm/rev)	Depth (mm)	Feed (mm/rev)	Depth (mm)
<b>P</b>	Carbon steel, alloy steel 45#, 42CrMo	HB180-280	Finishing	0.05-0.1-0.15	<0.2	0.05-0.1-0.15	<0.2				
			Semi-finishing	0.15-0.25-0.35	<3.0	0.1-0.15-0.2	<1.5				
<b>M</b>	Stainless steel 1Cr18Ni9Ti, 0Cr18Ni9	≤HB220	Finishing	0.05-0.1-0.15	<0.2	0.05-0.1-0.15	<0.2				
			Semi-finishing	0.15-0.2-0.25	<2.0	0.1-0.15-0.2	<1.0				
<b>N</b>	Aluminium alloy	---	Finishing	0.05-0.1-0.15	<0.2	0.05-0.1-0.15	<0.2	0.05-0.1-0.15	-0.15	0.05-0.1-0.15	<0.1
			Semi-finishing	0.05-0.1-0.15	<2.0	0.05-0.1-0.15	<1.5	0.05-0.1-0.15	-1.0	0.05-0.1-0.15	<1.0

Note: Blue word is recommended cutting parameter

### Common problems and solution

Problems	Reason	solution	Material		Cutting condition			Shape					Machine clamping						
			Material with higher hardness	Material with better toughness	Cutting speed	Feed rate	Cutting depth	Cutting liquid	Change insert groove	Rake angle	Nose radius	Approach angle	Strength of cutting edge	Improve insert accuracy	Improve the rigidity of toolholder	Improve the rigidity of workpiece	Clamping system of workpiece	Overhang of tool	Power gap
Sawee abrasion of tool nose	Bad precision in machining	Flank surface of blade insert wear increased	✓																
		Cutting condition is not appropriate			↓	↑													
Surface accuracy deterioration	Poor surface quality	Tool wear increase and cutting edge not sharp enough	✓		↓			✓		↑	↑	↓	✓						
		Fracture of cutting edge		✓		↓	↓		✓		↑	↑			✓	✓	✓		
		Unsuitable geometrical shape of cutting edge							✓		↑	↓	✓						
		Cutting condition is not appropriate			↑	↓	↓	✓											
		Vibration, tremble		✓		↓	↓	✓	✓	↑	↓	↑	↓		✓	✓	✓	✓	
	Built-up edge			↑	↑		✓	✓	↑		↓	✓							
Thermal	The influence of cutting heat	Cutting condition is not appropriate			↓	↓	↓												
		Unsuitable geometrical shape of cutting edge	✓						✓	↑		↓							
Poor dimension accuracy	Unstable size	Insert tolerance											✓						
		Offset of workpiece or tools							✓	↑	↓	↑		✓	✓	✓	✓		
Fracture of cutting edge	Flank surface	Abrasion on clearance angle	✓		↓				✓	↑	↑	↓							
		Abrasion on rake angle	✓		↓	↓	↓		✓	↑		↓							
	Edge chipping		✓		↓	↓		✓			↓	↑		✓	✓	✓	✓		
	Built-up edge	The hardness of workpiece and cutting condition does not adapt			↑	↑		✓	✓	↑		↓	✓						
Heat crack	The hardness of workpiece and cutting tool materials and cutting condition does not adapt				↓	↓	↓	✓	✓	↑		↓							
		Deformation of cutting edge nose	✓		↑	↓	↓	✓	✓	↑	↑	↓	↓						
		Tool life	Material and cutting condition is not appropriate	✓		↓	↓		✓		↑	↓	↑		✓	✓	✓	✓	
Chippings control	Long chip winding	Cutting condition is not appropriate			↓	↑	↑	✓											
		Unsuitable geometrical shape of cutting edge							✓		↓	↑							
Chip is shot lead to solash	Cutting condition is not appropriate				↓	↓		✓											
		Unsuitable geometrical shape of cutting edge							✓		↑	↓							
Burr, side collapse	Steel aluminum produce burr	Cutting condition is not appropriate			↑	↓		✓											
		Tool abrasion and unsuitable geometrical shape	✓						✓	↑	↓	↑	↓						
	Cast iron, the collapse edge	Cutting condition is not appropriate			↓	↑			✓	✓	↓	↓	↓						
		Tool abrasion and unsuitable geometrical shape	✓						✓		↓	↓	↓						
Mild steel, the burrs	Cutting condition is not appropriate				↓	↓													
		Tool abrasion and unsuitable geometrical shape	✓						✓	↑	↑		↑		✓	✓	✓	✓	



### ■ Abrasion of tools and various damages

Tool damage type	Phenomenon	Reason	Solution
flank wear	cutting resistance increase groove wear gradually in flank surface	tool material is too soft cutting speed is too high the clearance angle is too small low feed	<ul style="list-style-type: none"> <li>◆ choose tool materials of high wear resistance</li> <li>◆ lower cutting speed</li> <li>◆ increase clearance angle</li> <li>◆ increase cutting feed</li> </ul>
rake face wear (crater wear)	chipbreaking control is bad surface quality deterioration	tool material is too soft cutting speed is too high high feed	<ul style="list-style-type: none"> <li>◆ choose tool materials of high wear resistance</li> <li>◆ lower cutting speed</li> <li>◆ reduce cutting feed</li> </ul>
cutting edge breakage	sudden collapse edge tool life is unstable	tool material is too tough high feed cutting intensity is not enough tool rod and handle less rigid	<ul style="list-style-type: none"> <li>◆ choose higher material toughness</li> <li>◆ reduce cutting feed</li> <li>◆ increase the edge grinding (if rounding, chamfer instead)</li> <li>◆ increase the toolholder size</li> </ul>
damage	cutting resistance increase deterioration of the surface roughness	tool material is too tough high cutting feed cutting edge strength is not enough tool rod and handle less rigid	<ul style="list-style-type: none"> <li>◆ choose higher material toughness</li> <li>◆ reduce cutting feed</li> <li>◆ increase the edge grinding (if rounding, chamfer instead)</li> <li>◆ increase the toolholder size</li> </ul>
plastic deformation (cutting edge collapse)	workpiece size change nose abrasion	tool material is too soft cutting speed is too high cutting depth and feed are too high cutting depth and feed is too high cutting edge temperature is too high	<ul style="list-style-type: none"> <li>◆ choose tool materials of high wear resistance</li> <li>◆ lower cutting speed</li> <li>◆ reduce cutting depth and feed</li> <li>◆ use high thermal conductivity of tool materials</li> </ul>
built-up edge (bond)	finishing surface deterioration cutting resistance increase	low cutting speed cutting edge is not sharp tool material is not suitable	<ul style="list-style-type: none"> <li>◆ higher cutting speed</li> <li>◆ increase rake angle</li> <li>◆ choose small affinity tool material (coating, cermet, etc.)</li> </ul>
heat crack	collapse loss due to thermal cycling in interrupted cutting	expansion and contraction caused by cutting heat tool material is too tough	<ul style="list-style-type: none"> <li>◆ dry cutting</li> <li>◆ choose higher material toughness</li> </ul>
boundary wear	produce burr cutting resistance increase	high feed, high cutting speed	<ul style="list-style-type: none"> <li>◆ choose tool materials of high wear resistance</li> <li>◆ increase rake angle to improve the edge sharpness</li> <li>◆ lower cutting speed</li> </ul>
peel off	usually occurring in high hardness materials, vibration cutting	cutting edge bonding poor chip removal	<ul style="list-style-type: none"> <li>◆ increase rake angle to improve the edge sharpness</li> <li>◆ increase the chip flute</li> </ul>

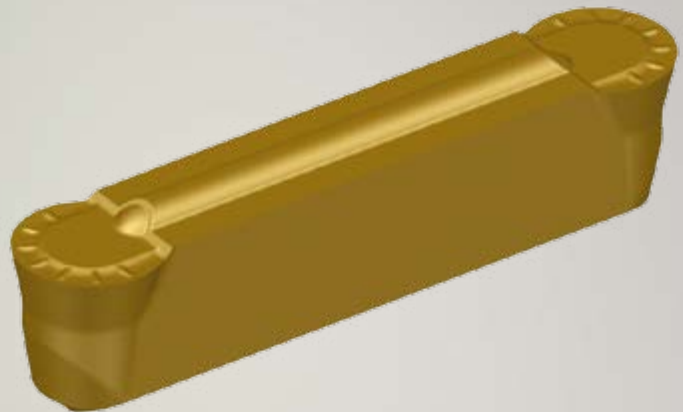
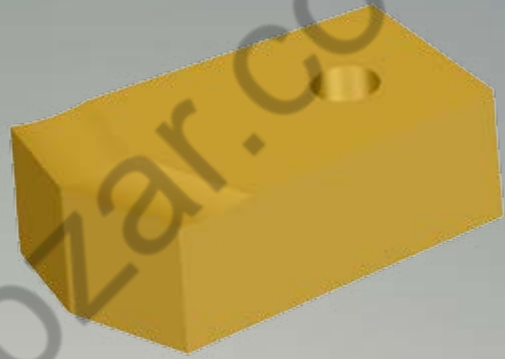
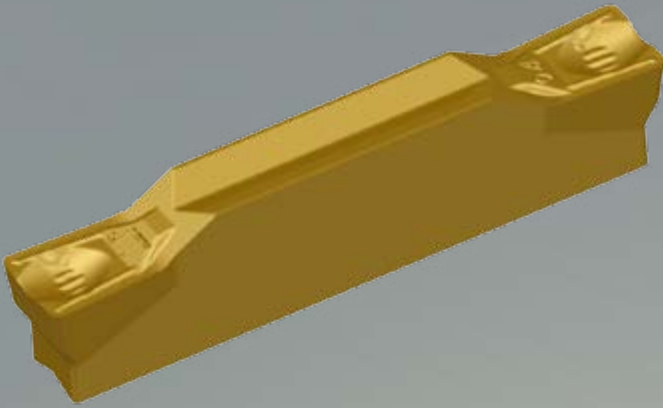

BavandAbzar.com

# Turning

## Parting and grooving tools

Parting and grooving inserts	A156-A165
Sharp solid series grooving insert naming rules	A156-A165
Sharp solid series grooving insert	A157-A159
Parting and grooving processing applicable data	A181-A182

# Turning

## Parting and grooving tools

### Grooving insert

A

Common turning Parting and grooving

#### Sharp solid series grooving insert naming rules

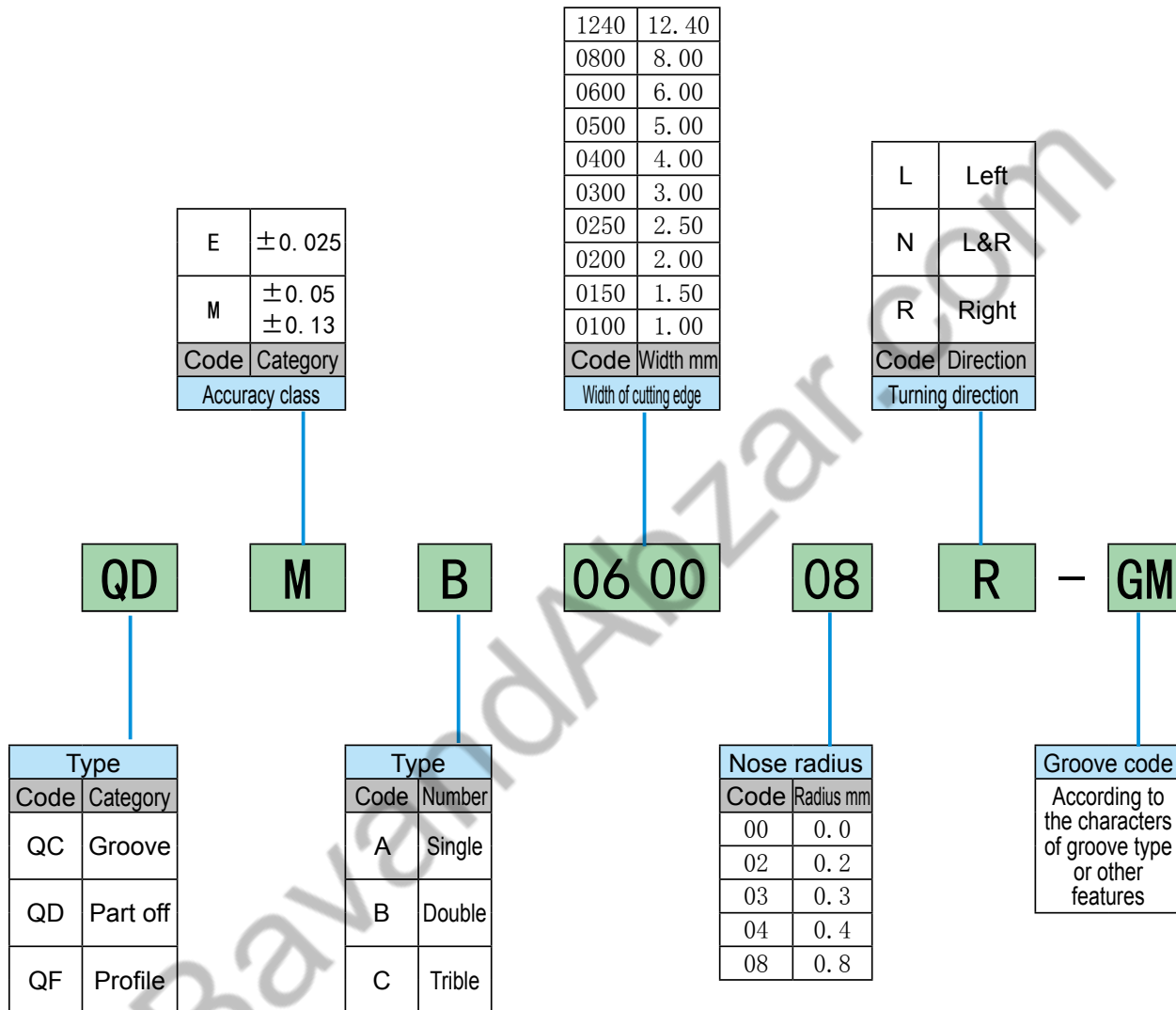



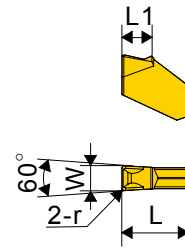

Type	Dimension(mm)				Coated cemented carbide												Cemented carbide										
	L	W	r	d	P						M						K						JP302	JP402	JK002	JK102	JK202
					JT4015	JT4115	JT4025	JT4125	JT4035	JT4135	JT1015	JT1025	JT1035	JT1045	JT4330	JT4340	JT4350	JT3105	JT3205	JT3115	JT3215	JT3125					
QDMA030003N	11.0	3.12	0.30	4.40	○	☆	★					★						○	★	☆			☆				○
QDMA040003N	11.0	4.12	0.30	4.95	○	☆	★					★						○	★	☆			☆				○
QDMA050003N	11.0	5.1	0.30	5.00	○	☆	★					★						○	★	☆			☆				○
QDMA064003N	11.0	6.40	0.30	5.28	○	☆	★					★						○	★	☆			☆				○
QDMA100005N	16.2	9.85	0.50	8.35	○	☆	★					★						○	★	☆			☆				○

★ Recommended grade for stock ☆ Optional grade for stock ○ Make-to-order

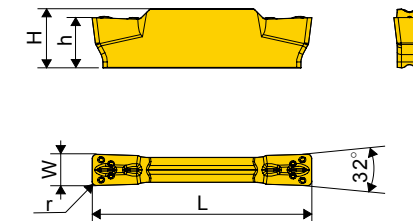

Type	Dimension(mm)					Coated cemented carbide												Cemented carbide																		
	L	W	r	h	H	P						M						K						JP302	JP402	JK002	JK102	JK202								
						JT4015	JT4115	JT4025	JT4125	JT4035	JT4135	JT1015	JT1025	JT1035	JT1045	JT4330	JT4340	JT4350	JT3105	JT3205	JT3115	JT3215	JT3125						JT3225							
QCMB020002N-GM	16.0	2.00	0.20	3.50	3.98			☆	★										★									☆	★							
QCMB030004N-GM	21.0	3.00	0.40	4.80	5.63			☆	★										★									☆	★							
QCMB050004N-GM	21.0	4.00	0.40	4.80	5.88			☆	★										★									☆	★							
QCMB050008N-GM	26.05	5.03	0.80	5.85	7.05			☆	★										★									☆	★							
QCMB060008N-GM																																				

★ Recommended grade for stock ☆ Optional grade for stock ○ Make-to-order

#### Profile cutting

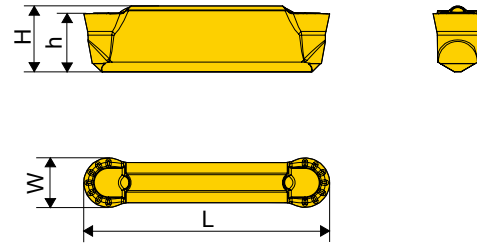

Type	Dimension(mm)					Coated cemented carbide															Cemented carbide								
						P					M					K													
	L	W	r	h	H	JT4015	JT4115	JT4025	JT4125	JT4035	JT4135	JT1015	JT1025	JT1035	JT1045	JT4330	JT4340	JT4350	JT3105	JT3205	JT3115	JT3215	JT3125	JT3225	JP302	JP402	JK002	JK102	JK202
QFMB030000NK-GM	20.05	3.12	-	4.16	4.84	○	☆	★				★	☆							★	☆				☆				
QFMB040000NK-GM	20.10	4.14	-	4.90	5.75	○	☆	★				★	☆							★	☆				☆				
QFMB050000NK-GM	25.15	5.05	-	5.95	6.75	○	☆	★				★	☆							★	☆				☆				
QFMB060000NK-GM	30.20	5.15	-	5.66	6.95	○	☆	★				★	☆							★	☆				☆				

★ Recommended grade for stock ☆ Optional grade for stock ○ Make-to-order

#### Grooving and turning insert

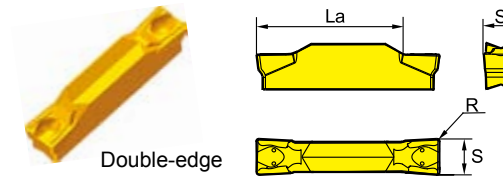

Type	Dimension(mm)			Grade						
				Coated cemented carbide CVD			Coated cemented carbide PVD		Uncoated cemented carbide	
	S <sup>+0.1</sup> <sub>0</sub>	R <sub>±0.10</sub>	Max cutting depth L <sub>max</sub>	JT4025	JT4125	JT4225	JT1215	JT1125	JK101	
Double-edge	QCMB025003N-MT	2.5	0.3	17	○		○	●	★	
	QCMB03003N-MT	3.0	0.3	17	○		○	●	★	
	QCMB04004N-MT	4.0	0.4	22	●		○	●	★	
	QCMB05004N-MT	5.0	0.4	22			○	●	★	
	QCMB06008N-MT	6.0	0.8	22			○	●	★	
One-edge	QCMA05004N-MT	5.0	0.4				○	○	○	
	QCMA06008N-MT	6.0	0.8				○	○	○	

★ Recommended grade for stock ☆ Optional grade for stock ○ Make-to-order

## Part off and groove tool center height control

- No matter what tool you choose, only guarantee the blade and the center line of the workpiece installation into 90 degree, to obtain the ideal processing surface, and reduce the vibration phenomenon in processing.
- Blade edge line with the workpiece center height tolerance should maintain  $\pm 0.1$  mm, especially bar cutting and grooving of small diameter workpiece, can increase the tool life, reduce the cutting resistance, decrease the burr.

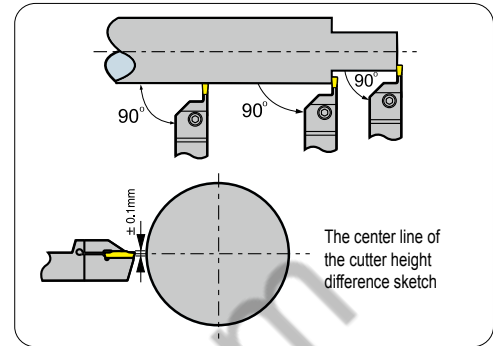

### Parting off

- When the blade close to the workpiece center, should reduce the feed rate of 30%, to improve tool life and surface quality.
- Under permission, decrease overhanging as far as possible, to ensure good stability.

### External grooving and turning, profiling

- Feeding order: cutting depth  $> 0.5$  mm, the radial feed (maximum cutting depth can be  $0.75 \times \text{edge width } S$ )  $\rightarrow$  radial return around  $0.1$  mm  $\rightarrow$  axial feeding  $\rightarrow$  oblique knife back  $\rightarrow$  axial feeding  $\rightarrow$  radial processing to the required depth.
- Bottom diameter or chamfer (finishing), uses the operating sequence as shown, can reduce the friction of tool and chip and small vibration.

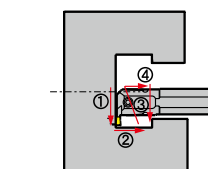
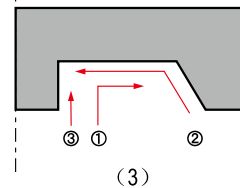
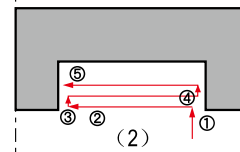
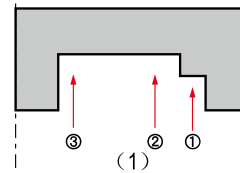
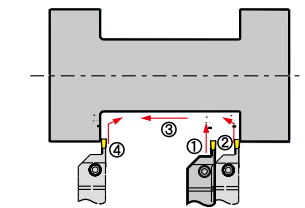
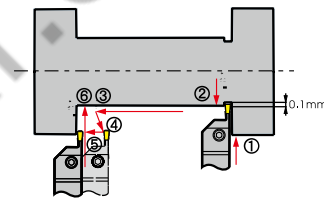

### Face grooving and turning

- Finishing (multiple groove turning)  
From the max diameter cutting inside, return when the edge of the blade slightly inward migration. See (1)
- The groove turning  
The axial cutting depth is less than  $0.75 \times S$  (Width of cutting edge)  
Groove width greater than groove depth, it is recommended to use groove cutting. See (2)  
Groove depth greater than groove width, it is recommended to use multiple groove cutting
- Finishing  
Finishing bottom and outside edge at the first, and then finishing bore to the required size. See (3)

### Internal grooving and turning

- Using the graphic processing order  
Easy to chip outflow, away from the end of the hole direction always start to feed

# Turning

## Parting and grooving tools

Parting and grooving processing applicable data

A

Common turning Parting and grooving

Parting and grooving processing applicable data

### Cutting dosage recommended list of parting and grooving tools

Dimension	Recommended cutting feed(mm/r)				
	Width (mm)	Cutting-off	Grooving	Turning	Profiling
2		0.05—0.15	0.05—0.15	0.05—0.15	0.05—0.15
2.5		0.05—0.15	0.05—0.15	0.05—0.15	0.05—0.15
3		0.05—0.15	0.05—0.15	0.07—0.15	0.1—0.2
4		0.05—0.2	0.05—0.2	0.07—0.25	0.1—0.2
5		0.07—0.2	0.07—0.22	0.1—0.25	0.15—0.3
6		0.1—0.3	0.07—0.25	0.1—0.3	0.15—0.3

Add:JT4015/JT4115/JT4215/JT1025/JT1235

Workpiece	Hardness	JT1025	JT1235	JT1215	JT4025	JT4225	JT3215	JT3225	JT1035	JP302	JP402
P Carbon steel	125≤HB≤170	150-280		150-280	140-280	150-280				130-280	110-260
	Low alloy steel	180≤HB≤275	110-200		110-200	100-240	110-200			90-200	70-175
	High alloy steel	180≤HB≤325	110-190		110-190	100-220	110-190			90-190	70-160
	Cast iron	180≤HB≤250	100-170		100-170	80-160	100-170			80-170	60-140
M Ferrite martensite	200≤HB≤300	100-200		100-200		100-200				80-200	60-170
	Austenite	180≤HB≤300	110-220		110-220	110-220				90-220	70-200
K Malleable cast iron	130≤HB≤230	130-220		130-220				90-160			
	Gray cast iron	180≤HB≤220	120-200		120-200			80-140			
	Nodular cast iron	160≤HB≤250	110-180		110-180			60-140			
N Aluminium alloy	--						200-400				
S High temperature alloy	≤400						20-50		30-60		

Cutting parameter suitable for wet processing.

Suggestion:Cutting speed should be reduced by 30% - 40% for internal and face turning.









# Turning

## Thread turning insert

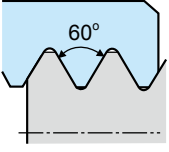
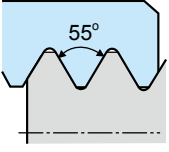
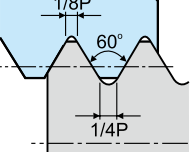
Thread insert overview	A184-A186
Grade and chipbreaker structure of thread insert	A187
Thread insert	A188-A208
Thread insert naming rules	A188
Partial profile 60°	A189
Partial profile 55°	A190
ISO Metric	A191
American UN	A195
Whit Worth	A199
British Standard Thread	A203
American 60°Tape Pipe Thread	A204
National pipe Thread-Dry seal	A205
Round DIN405	A206
Trapez DIN103	A207
ACME American ACME	A208
Thread tool	A209-A211
Thread tool naming rules	A209
External thread turning tool	A210
Internal thread turning tool	A211
Technical information for threading	A212-A226







# Turning

Thread cutting tool  
Thread insert overview

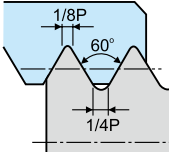
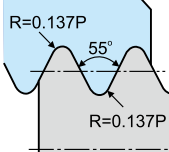
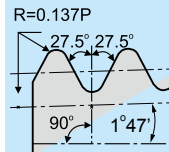
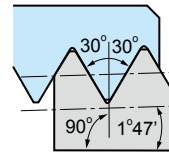
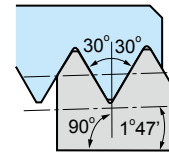
Use		General machinery		
Diagram				
Name		Partial profile 60°	Partial profile 55°	ISO Metric
Thread form		<b>60</b>	<b>55</b>	<b>GM</b>
Shape (Length, 11, 16, 22mm)		Here is for R type external thread  A189	Here is for R type external thread  A190	Here is for R type external thread  A191
toolholder	Pitch	Pitch/mm(Number/Inch)	Pitch/mm(Number/Inch)	Pitch/mm
	Tool shank size(mm) (H×W×L) (D×L× Min D)			
External thread	 Here is for R type A210	16×16×100 20×20×125 25×25×150 32×25×170 32×32×170 40×40×250	0.5~6.0 (5~48)	0.5~6.0 (5~48)
	 R type A211	16×125×12 16×150×16 16×150×20 20×150×25 20×180×25 25×150×32 32×200×40 32×250×40 40×300×50 50×350×63	0.5~6.0 (5~48)	0.5~6.0 (5~48)

Thread cutting tool  
Thread insert overview

# Turning

The aerospace industry	General machinery	Heating, gas, water	Gas, water	gas and conduit pipe
				
American	Whit Worth	British Standard Pipe Thread	American 60°Tape Pipe Thread	National Pipe Thread-Dry seal
<b>UN</b>	<b>W</b>	<b>BSP</b>	<b>NPT</b>	<b>NPTF</b>
R type,external  A195	R type,external  A199	R type,external  A203	R type,external  A204	R type,external  A205
Pitch/mm(Number/Inch)	Pitch/mm(Number/Inch)	Pitch/mm(Number/Inch)	Pitch/mm(Number/Inch)	Pitch/mm(Number/Inch)
72~4	72~4	28~11	27~8	27~8
72~4	72~4	28~11	27~8	27~8

A

Common turning Parting and grooving

Thread insert

Thread insert overview

A

Common turning Parting and grooving

Thread insert

Thread insert overview

# Turning





Thread cutting tool  
Thread insert overview

A

Common turning Parting and grooving

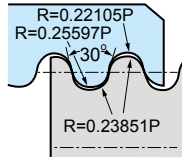
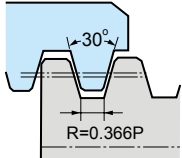
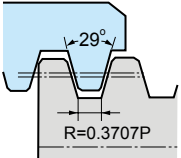
Thread insert

Thread insert overview

Usage		The food	Trapezoidal screw	Trapezoidal screw
Diagram				
Thread name		Round DIN405	Trapes DIN 103	American trapezd thread
Thread tooth form		<b>R</b>	<b>Tr</b>	<b>ACME</b>
Shape (Length: 11,16,22mm)		R type,external  A206	R type,external  A207	R type,external  A208
Toolholder dimension(mm) (H×W×L) (D×L×Min D)		Pitch/mm(Number/Inch)	Pitch/mm	Pitch/mm(Number/Inch)
External thread	16×16×100	10~4	1.5~6.0	16~4
	20×20×125			
	25×25×150			
	32×25×170			
	32×32×170			
40×40×250				
Internal thread	16×125×12	10~4	1.5~6.0	16~4
	16×150×16			
	16×150×20			
	20×150×25			
	20×180×25			
	25×150×32			
	32×200×40			
	32×250×40			
	40×300×50			
	50×350×63			

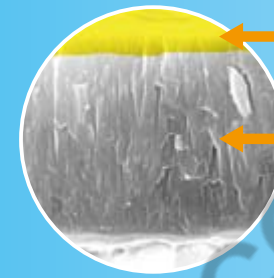

Golden yellow TiN surface reduces friction and wear recognition effect

The inner nc - TiAlN coatings have excellent wear resistance

## JT1125

Nc - TiAlN coatings combined with ultra fine particles of strong toughness matrix, is suitable for all kinds of processed material of finishing and semi-finishing and high temperature alloy rough turning processing.

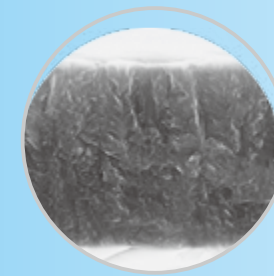

Nc - TiAlN coatings combined with ultra fine particles of strong toughness matrix, is suitable for all kinds of processed material of finishing and semi-finishing and high temperature alloy rough turning processing.

## JT1025

TiN and PVD coating alloy, with good toughness and wear resistance, it is a special grade for machining of carbon steel, stainless steel and cast iron, etc.

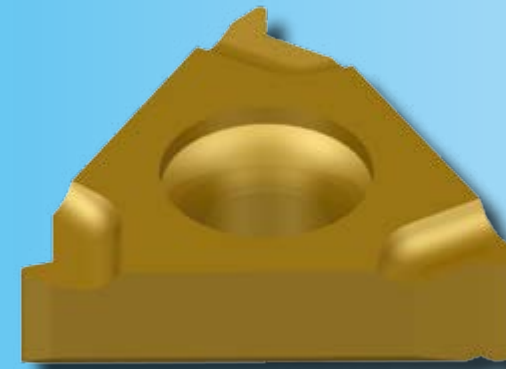

# Turning

Thread cutting tool  
Thread insert

## Thread insert naming rules

### Insert size

- 11 > On behalf of  $C=6.35$  mm
- 16 > On behalf of  $C=9.525$  mm
- 22 > On behalf of  $C=12.7$  mm
- 27 > On behalf of  $C=15.875$  mm

### Insert size

- E** > External thread turning insert
- N** > Internal thread turning insert

### Cutting direction

- R** > Right
- L** > Left

**16** **E** **R** - **1.5** **ISO**

### Pitch

Full profile (The number is the pitch range)

	mm	TPI
	0.35-9.0	72-2
V partial (The number is the pitch range)		
	mm	TPI
<b>A</b>	0.5-1.5	48-16
<b>AG</b>	0.5-3.0	48-8
<b>G</b>	1.75-3.0	14-8
<b>N</b>	3.5-5.0	7-5
<b>Q</b>	5.5-6.0	41/2-4

### Tooth type of thread

60°	Partial profile 60°
55°	Partial profile 55°
ISO	ISO Metric
UN	American UN
UNJ	Unified Constant Thread
W	Whitworth
NPT	American 60°Tape Pipe Thread
NPTF	National Pipe Threads-Dry seal
BSPT	British Standard 55°Pipe Thread
ACME	American ACME
STACME	Stub ACME
TR	Trapes DIN 103
ABUT	American Buttress
RD	Round DIN 405
APIRD	API Round Thread

Thread cutting tool  
Thread insert

# Turning

## Common thread

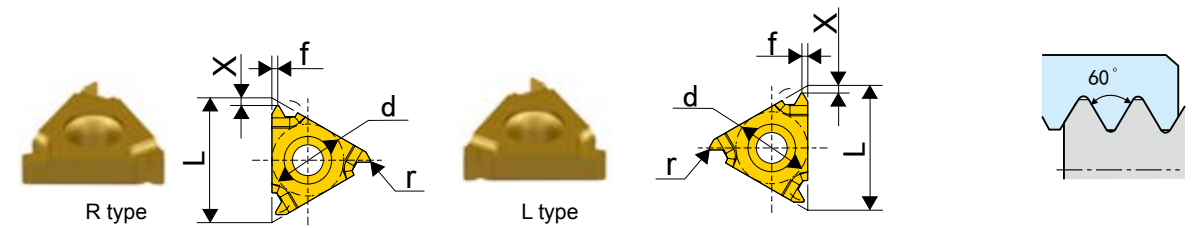

Type	Oesignnation Right	Oesignnation Left	Pitch(mm)	TPI	Dimensions(mm)				Recommended grade			
					d	L	X	f	JT1025		JT1125	
									R	L	R	L
External	11ER-A60	11EL-A60	0.5-1.5	48-16	6.35	11	0.8	0.9	★	★	★	★
	11ER-G60	11EL-G60	1.75-3.0	14-8	9.525	16	1.2	1.7	★	★	★	★
	11ER-AG60	11EL-AG60	0.5-3.0	48-8	9.525	16	1.2	1.7	★	★	★	★
	22ER-N60	22EL-N60	3.5-5.0	7-5	12.7	22	1.7	2.5	★	★	★	★
	27ER-Q60	27EL-Q60	5.5-6.0	4.5-4	15.875	27	2.1	3.1	★	★	★	★

★Recommended grade ☆Optional grade ○Make to order

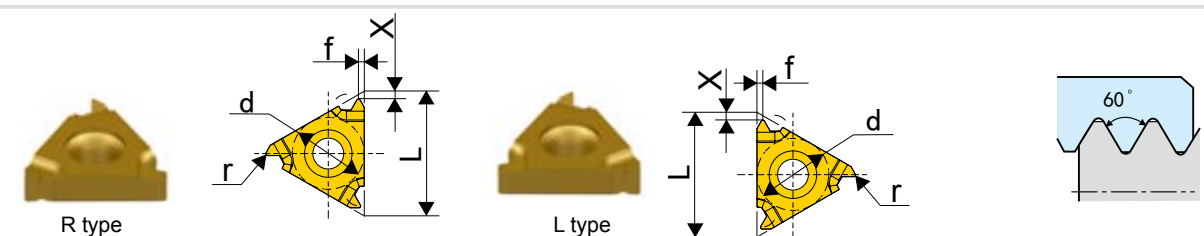

Type	Oesignnation Right	Oesignnation Left	Pitch(mm)	TPI	Dimensions(mm)				Recommended grade			
					d	L	X	f	JT1025		JT1125	
									R	L	R	L
Internal	11NR-A60	11NL-A60	0.5-1.5	48-16	6.35	11	0.8	0.9	★	★	★	★
	11NR-G60	11NL-G60	1.75-3.0	14-8	9.525	16	1.2	1.7	★	★	★	★
	11NR-AG60	11NL-AG60	0.5-3.0	48-8	9.525	16	1.2	1.7	★	★	★	★
	22NR-N60	22NL-N60	3.5-5.0	7-5	12.7	22	1.7	2.5	★	★	★	★
	27NR-Q60	27NL-Q60	5.5-6.0	4.5-4	15.875	27	1.8	2.7	★	★	★	★

★Recommended grade ☆Optional grade ○Make to order



# Turning

Thread cutting tool  
Thread insert

## Common thread

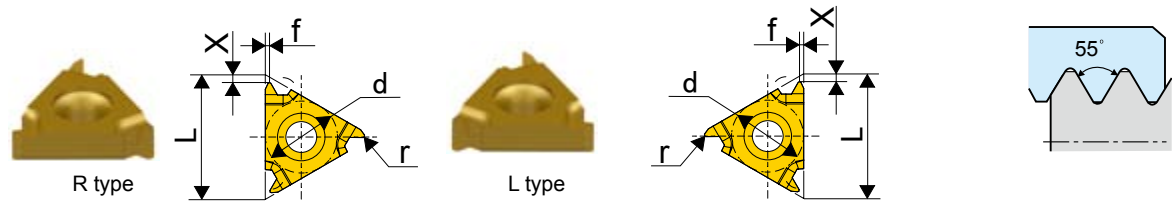

Type	Oesignnation Right	Oesignnation Left	Pitch(mm)	TPI	Dimensions(mm)				Recommende d grade		Recommende d grade	
					d	L	X	f	JT1025		JT1125	
									R	L	R	L
External	11ER-A55	11EL-A55	0.5-1.5	48-16	6.35	11	0.8	0.9	★	★	★	★
	11ER-G55	11EL-G55	1.75-3.0	14-8	9.525	16	1.2	1.7	★	★	★	★
	11ER-AG55	11EL-AG55	0.5-3.0	48-8	9.525	16	1.2	1.7	★	★	★	★
	22ER-N55	22EL-N55	3.5-5.0	7-5	12.7	22	1.7	2.5	★	★	★	★
	27ER-Q55	27EL-Q55	5.5-6.0	4.5-4	15.875	27	2	2.9	★	★	★	★

★Recommended grade ☆Optional grade ○Make to order

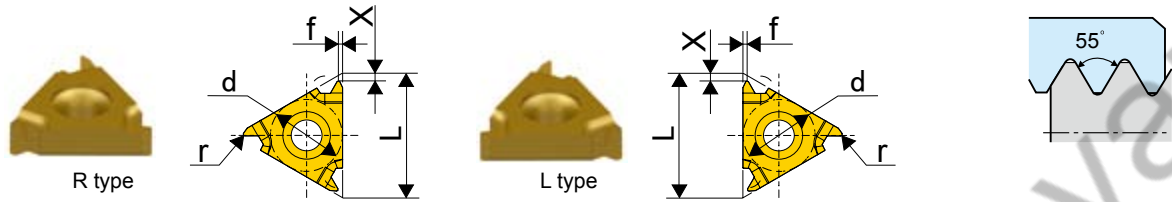

Type	Oesignnation Right	Oesignnation Left	Pitch(mm)	TPI	Dimensions(mm)				Recommende d grade		Recommende d grade	
					d	L	X	f	JT1025		JT1125	
									R	L	R	L
Internal	11NR-A55	11NL-A55	0.5-1.5	48-16	6.35	11	0.8	0.9	★	★	★	★
	11NR-G55	11NL-G55	1.75-3.0	14-8	9.525	16	1.2	1.7	★	★	★	★
	11NR-AG55	11NL-AG55	0.5-3.0	48-8	9.525	16	1.2	1.7	★	★	★	★
	22NR-N55	22NL-N55	3.5-5.0	7-5	12.7	22	1.7	2.5	★	★	★	★
	27NR-Q55	27NL-Q55	5.5-6.0	4.5-4	15.875	27	2	2.9	★	★	★	★

★Recommended grade ☆Optional grade ○Make to order

Thread cutting tool  
Thread insert

# Turning

## ISO Metric

ISO 965-1980 DIN 13  
GB/T 197-2003 Tolerance class:6g/6H

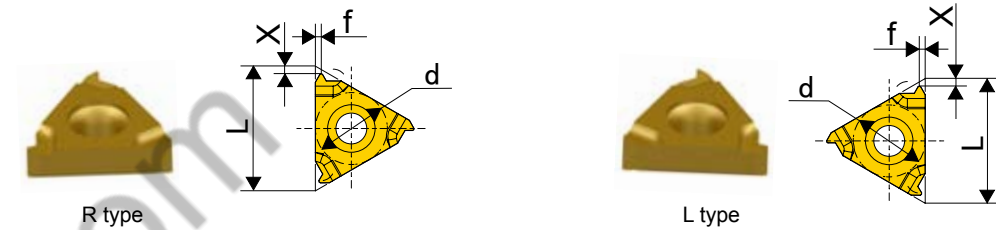
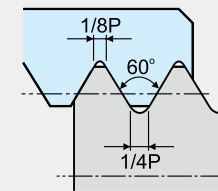

Type	Oesignnation Right	Oesignnation Left	TPI	Dimensions(mm)				Recommende d grade		Recommende d grade	
				d	L	X	f	JT1025		JT1125	
								R	L	R	L
External	11ER-0.35ISO	11EL-0.35ISO	0.35	6.35	11	0.8	0.4	★	★	★	★
	11ER-0.45ISO	11EL-0.45ISO	0.45	6.35	11	0.7	0.4	★	★	★	★
	11ER-0.5ISO	11EL-0.5ISO	0.5	6.35	11	0.6	0.4	★	★	★	★
	11ER-0.6ISO	11EL-0.6ISO	0.6	6.35	11	0.6	0.6	★	★	★	★
	11ER-0.75ISO	11EL-0.75ISO	0.75	6.35	11	0.6	0.6	★	★	★	★
	11ER-0.8ISO	11EL-0.8ISO	0.8	6.35	11	0.6	0.6	★	★	★	★
	11ER-1.0ISO	11EL-1.0ISO	1	6.35	11	0.7	0.7	★	★	★	★
	11ER-1.25ISO	11EL-1.25ISO	1.25	6.35	11	0.8	0.9	★	★	★	★
	11ER-1.5ISO	11EL-1.5ISO	1.5	6.35	11	0.8	1	★	★	★	★
	11ER-1.75ISO	11EL-1.75ISO	1.75	6.35	11	0.8	1.1	★	★	★	★
	16ER-0.35ISO	16EL-0.35ISO	0.35	9.525	16	0.8	0.4	★	★	★	★
	16ER-0.4ISO	16EL-0.4ISO	0.4	9.525	16	0.7	0.4	★	★	★	★
	16ER-0.45ISO	16EL-0.45ISO	0.45	9.525	16	0.7	0.4	★	★	★	★
	16ER-0.5ISO	16EL-0.5ISO	0.5	9.525	16	0.6	0.4	★	★	★	★
	16ER-0.6ISO	16EL-0.6ISO	0.6	9.525	16	0.6	0.6	★	★	★	★
	16ER-0.7ISO	16EL-0.7ISO	0.7	9.525	16	0.6	0.6	★	★	★	★
	16ER-0.75ISO	16EL-0.75ISO	0.75	9.525	16	0.6	0.6	★	★	★	★
	16ER-0.8ISO	16EL-0.8ISO	0.8	9.525	16	0.6	0.6	★	★	★	★

★Recommended grade ☆Optional grade ○Make to order

# Turning

Thread cutting tool  
Thread insert

ISO Metric

ISO 965-1980 DIN 13  
GB/T 197-2003 Tolerance class:6g/6H

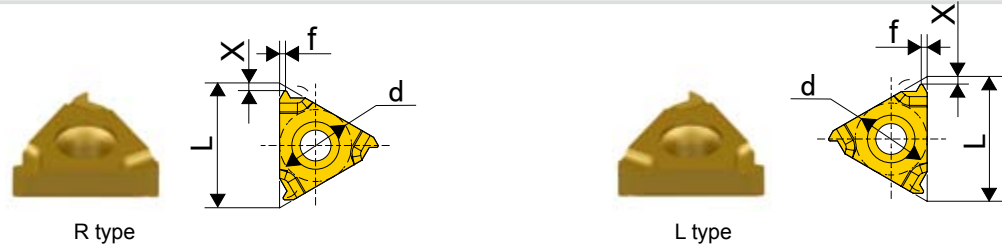
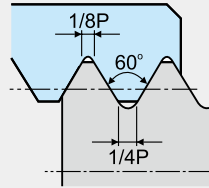

Type	Oesignnation Right	Oesignnation Left	TPI	Dimensions(mm)				Recommended grade		Recommended grade	
				d	L	X	f	JT1025		JT1125	
								R	L	R	L
External	16ER-1.0ISO	16EL-1.0ISO	1	9.525	16	0.7	0.7	★	★	★	★
	16ER-1.25ISO	16EL-1.25ISO	1.25	9.525	16	0.8	0.9	★	★	★	★
	16ER-1.5ISO	16EL-1.5ISO	1.5	9.525	16	0.8	1	★	★	★	★
	16ER-1.75ISO	16EL-1.75ISO	1.75	9.525	16	0.9	1.2	★	★	★	★
	16ER-2.0ISO	16EL-2.0ISO	2	9.525	16	1	1.3	★	★	★	★
	16ER-2.5ISO	16EL-2.5ISO	2.5	9.525	16	1.1	1.5	★	★	★	★
	16ER-3.0SO	16EL-3.0ISO	3	9.525	16	1.2	1.6	★	★	★	★
	22ER-3.5ISO	22EL-3.5ISO	3.5	12.7	22	1.6	2.3	★	★	★	★
	22ER-4.0ISO	22EL-4.0ISO	4	12.7	22	1.6	2.3	★	★	★	★
	22ER-4.5ISO	22EL-4.5ISO	4.5	12.7	22	1.7	2.4	★	★	★	★
	22ER-5.0ISO	22EL-5.0ISO	5	12.7	22	1.7	2.5	★	★	★	★
	27ER-5.5ISO	27EL-5.5ISO	5.5	15.875	27	1.9	2.7	★	★	★	★
27ER-6.0ISO	27EL-6.0ISO	6	15.875	27	2	2.9	★	★	★	★	

★Recommended grade ☆Optional grade ○Make to order

Thread cutting tool  
Thread insert

# Turning

ISO Metric

ISO 965-1980 DIN 13  
GB/T 197-2003 Tolerance class:6g/6H

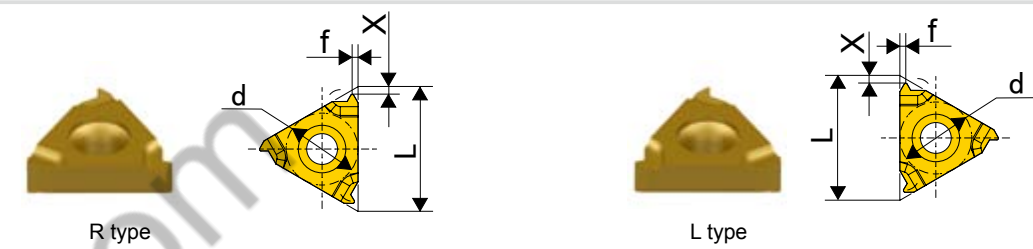
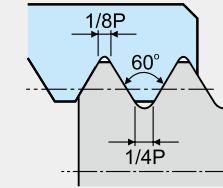

Type	Oesignnation Right	Oesignnation Left	TPI	Dimensions(mm)				Recommended grade		Recommended grade	
				d	L	X	f	JT1025		JT1125	
								R	L	R	L
Internal	11NR-0.35ISO	11NL-0.35ISO	0.35	6.35	11	0.8	0.3	★	★	★	★
	11NR-0.4ISO	11NL-0.4ISO	0.4	6.35	11	0.8	0.4	★	★	★	★
	11NR-0.45ISO	11NL-0.45ISO	0.45	6.35	11	0.8	0.4	★	★	★	★
	11NR-0.5ISO	11NL-0.5ISO	0.5	6.35	11	0.6	0.4	★	★	★	★
	11NR-0.6ISO	11NL-0.6ISO	0.6	6.35	11	0.6	0.6	★	★	★	★
	11NR-0.7ISO	11NL-0.7ISO	0.7	6.35	11	0.6	0.6	★	★	★	★
	11NR-0.75ISO	11NL-0.75ISO	0.75	6.35	11	0.6	0.6	★	★	★	★
	11NR-0.8ISO	11NL-0.8ISO	0.8	6.35	11	0.6	0.6	★	★	★	★
	11NR-1.0ISO	11NL-1.0ISO	1	6.35	11	0.6	0.7	★	★	★	★
	11NR-1.25ISO	11NL-1.25ISO	1.25	6.35	11	0.8	0.9	★	★	★	★
	11NR-1.5ISO	11NL-1.5ISO	1.5	6.35	11	0.8	1	★	★	★	★
	11NR-1.75ISO	11NL-1.75ISO	1.75	6.35	11	0.9	1.1	★	★	★	★
	11NR-2.0ISO	11NL-2.0ISO	2	6.35	11	0.9	1.1	★	★	★	★
	11NR-2.5ISO	11NL-2.5ISO	2.5	6.35	11	0.8	1.1	★	★	★	★
	16NR-0.35ISO	16NL-0.35ISO	0.35	9.525	16	0.8	0.3	★	★	★	★
	16NR-0.4ISO	16NL-0.4ISO	0.4	9.525	16	0.8	0.4	★	★	★	★
	16NR-0.45ISO	16NL-0.45ISO	0.45	9.525	16	0.8	0.4	★	★	★	★
	16NR-0.5ISO	16NL-0.5ISO	0.5	9.525	16	0.6	0.4	★	★	★	★
16NR-0.6ISO	16NL-0.6ISO	0.6	9.525	16	0.6	0.6	★	★	★	★	
16NR-0.7ISO	16NL-0.7ISO	0.7	9.525	16	0.6	0.6	★	★	★	★	

★Recommended grade ☆Optional grade ○Make to order

# Turning

Thread cutting tool  
Thread insert

## ISO Metric

ISO 965-1980 DIN 13  
GB/T 197-2003 Tolerance class:6g/6H

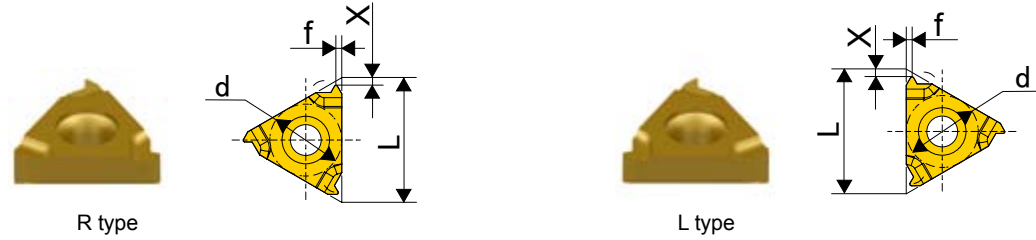
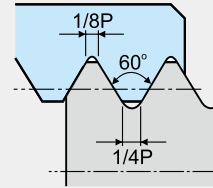

Type	Oesignation Right	Oesignation Left	TPI	Dimensions(mm)				Recommended grade		Recommended grade	
				d	L	X	f	JT1025		JT1125	
								R	L	R	L
Internal	16NR-0.75ISO	16NL-0.75ISO	0.75	9.525	16	0.6	0.6	★	★	★	★
	16NR-0.8ISO	16NL-0.8ISO	0.8	9.525	16	0.6	0.6	★	★	★	★
	16NR-1.0ISO	16NL-1.0ISO	1	9.525	16	0.6	0.7	★	★	★	★
	16NR-1.25ISO	16NL-1.25ISO	1.25	9.525	16	0.8	0.9	★	★	★	★
	16NR-1.5ISO	16NL-1.5ISO	1.5	9.525	16	0.8	1	★	★	★	★
	16NR-1.75ISO	16NL-1.75ISO	1.75	9.525	16	0.9	1.2	★	★	★	★
	16NR-2.0ISO	16NL-2.0ISO	2	9.525	16	1	1.3	★	★	★	★
	16NR-2.5ISO	16NL-2.5ISO	2.5	9.525	16	1.1	1.5	★	★	★	★
	16NR-3.0SO	16NL-3.0ISO	3	9.525	16	1.1	1.5	★	★	★	★
	22NR-3.5ISO	22NL-3.5ISO	3.5	12.7	22	1.6	2.3	★	★	★	★
	22NR-4.0ISO	22NL-4.0ISO	4	12.7	22	1.6	2.3	★	★	★	★
	22NR-4.5ISO	22NL-4.5ISO	4.5	12.7	22	1.6	2.4	★	★	★	★
	22NR-5.0ISO	22NL-5.0ISO	5	12.7	22	1.6	2.3	★	★	★	★
	27NR-5.5ISO	27NL-5.5ISO	5.5	15.875	27	1.6	2.3	★	★	★	★
	27NR-6.0ISO	27NL-6.0ISO	6	15.875	27	1.8	2.5	★	★	★	★

★Recommended grade ☆Optional grade ○Make to order

Thread cutting tool  
Thread insert

# Turning

## American UN

ASME B1.1-1989  
Tolerance class:2A/2B

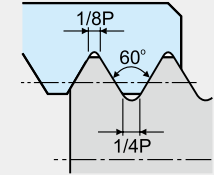

Type	Oesignation Right	Oesignation Left	TPI	Dimensions(mm)				Recommended grade		Recommended grade	
				d	L	X	f	JT1025		JT1125	
								R	L	R	L
External	11ER-72UN	11EL-72UN	72	6.35	11	0.8	0.4	★	★	★	★
	11ER-64UN	11EL-64UN	64	6.35	11	0.8	0.4	★	★	★	★
	11ER-56UN	11EL-56UN	56	6.35	11	0.7	0.4	★	★	★	★
	11ER-48U	11EL-48UN	48	6.35	11	0.6	0.6	★	★	★	★
	11ER-44UN	11EL-44UN	44	6.35	11	0.6	0.6	★	★	★	★
	11ER-40UN	11EL-40UN	40	6.35	11	0.6	0.6	★	★	★	★
	11ER-36UN	11EL-36UN	36	6.35	11	0.6	0.6	★	★	★	★
	11ER-32UN	11EL-32UN	32	6.35	11	0.6	0.6	★	★	★	★
	11ER-28UN	11EL-28UN	28	6.35	11	0.6	0.7	★	★	★	★
	11ER-27UN	11EL-27UN	27	6.35	11	0.7	0.8	★	★	★	★
	11ER-24UN	11EL-24UN	24	6.35	11	0.7	0.8	★	★	★	★
	11ER-20UN	11EL-20UN	20	6.35	11	0.8	0.9	★	★	★	★
	11ER-18UN	11EL-18UN	18	6.35	11	0.8	1	★	★	★	★
	11ER-16UN	11EL-16UN	16	6.35	11	0.9	1.1	★	★	★	★
	11ER-14UN	11EL-14UN	14	6.35	11	0.9	1.1	★	★	★	★
	16ER-72UN	16EL-72UN	72	9.525	16	0.8	0.4	★	★	★	★
	16ER-64UN	16EL-64UN	64	9.525	16	0.8	0.4	★	★	★	★
	16ER-56UN	16EL-56UN	56	9.525	16	0.7	0.4	★	★	★	★
	16ER-48UN	16EL-48UN	48	9.525	16	0.6	0.6	★	★	★	★
	16ER-44UN	16EL-44UN	44	9.525	16	0.6	0.6	★	★	★	★
16ER-40UN	16EL-40UN	40	9.525	16	0.6	0.6	★	★	★	★	

★Recommended grade ☆Optional grade ○Make to order

# Turning

Thread cutting tool  
Thread insert

## American UN

ASME B1.1-1989  
Tolerance class:2A/2B

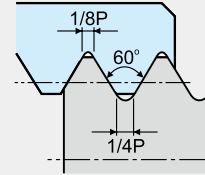

Type	Oesignnation Right	Oesignnation Left	TPI	Dimensions(mm)				Recommended grade		Recommended grade	
				d	L	X	f	JT1025		JT1125	
								R	L	R	L
External	16ER-36UN	16EL-36UN	36	9.525	16	0.6	0.6	★	★	★	★
	16ER-32UN	16EL-32UN	32	9.525	16	0.6	0.6	★	★	★	★
	16ER-28UN	16EL-28UN	28	9.525	16	0.6	0.7	★	★	★	★
	16ER-27UN	16EL-27UN	27	9.525	16	0.7	0.8	★	★	★	★
	16ER-24UN	16EL-24UN	24	9.525	16	0.7	0.8	★	★	★	★
	16ER-20UN	16EL-20UN	20	9.525	16	0.8	0.9	★	★	★	★
	16ER-18UN	16EL-18UN	18	9.525	16	0.8	1	★	★	★	★
	16ER-16UN	16EL-16UN	16	9.525	16	0.9	1.1	★	★	★	★
	16ER-14UN	16EL-14UN	14	9.525	16	1	1.2	★	★	★	★
	16ER-13UN	16EL-13UN	13	9.525	16	1	1.3	★	★	★	★
	16ER-12UN	16EL-12UN	12	9.525	16	1.1	1.4	★	★	★	★
	16ER-11.5UN	16EL-11.5UN	11.5	9.525	16	1.1	1.5	★	★	★	★
	16ER-11UN	16EL-11UN	11	9.525	16	1.1	1.5	★	★	★	★
	16ER-10UN	16ENL-10UN	10	9.525	16	1.1	1.5	★	★	★	★
	16ER-9UN	16EL-9UN	9	9.525	16	1.2	1.7	★	★	★	★
	16ER-8UN	16NEL-8UN	8	9.525	16	1.2	1.6	★	★	★	★
	22ER-7UN	22EL-7UN	7	12.7	22	1.6	2.3	★	★	★	★
	22ER-6UN	22EL-6UN	6	12.7	22	1.6	2.3	★	★	★	★
22ER-5UN	22EL-5UN	5	12.7	22	1.7	2.5	★	★	★	★	
27ER-4.5UN	27EL-4.5UN	4.5	15.875	27	1.9	2.7	★	★	★	★	
27ER-4UN	27EL-4UN	4	15.875	27	2.1	3	★	★	★	★	

★Recommended grade ☆Optional grade ○Make to order

Thread cutting tool  
Thread insert

# Turning

## American UN

ASME B1.1-1989  
Tolerance class:2A/2B

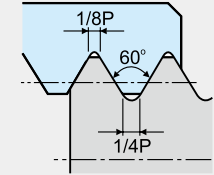

Type	Oesignnation Right	Oesignnation Left	TPI	Dimensions(mm)				Recommended grade		Recommended grade	
				d	L	X	f	JT1025		JT1125	
								R	L	R	L
Internal	11NR-72W	11NL-72W	72	6.35	11	0.7	0.4	★	★	★	★
	11NR-64W	11NL-64W	64	6.35	11	0.7	0.4	★	★	★	★
	11NR-56UN	11NL-56UN	56	6.35	11	0.7	0.4	★	★	★	★
	11NR-48U	11NL-48UN	48	6.35	11	0.6	0.6	★	★	★	★
	11NR-44UN	11NL-44UN	44	6.35	11	0.6	0.6	★	★	★	★
	11NR-40UN	11NL-40UN	40	6.35	11	0.6	0.6	★	★	★	★
	11NR-36UN	11NL-36UN	36	6.35	11	0.6	0.6	★	★	★	★
	11NR-32UN	11NL-32UN	32	6.35	11	0.6	0.6	★	★	★	★
	11NR-28UN	11NL-28UN	28	6.35	11	0.6	0.7	★	★	★	★
	11NR-27UN	11NL-27UN	27	6.35	11	0.7	0.8	★	★	★	★
	11NR-24UN	11NL-24UN	24	6.35	11	0.7	0.8	★	★	★	★
	11NR-20UN	11NL-20UN	20	6.35	11	0.8	0.9	★	★	★	★
	11NR-18UN	11NL-18UN	18	6.35	11	0.8	1	★	★	★	★
	11NR-16UN	11NL-16UN	16	6.35	11	0.9	1.1	★	★	★	★
	11NR-14UN	11NL-14UN	14	6.35	11	0.9	1.1	★	★	★	★
	11NR-12UN	11NL-12UN	12	6.35	11	0.8	1.1	★	★	★	★
	11NR-11UN	11NL-11UN	11	6.35	11	0.8	1.1	★	★	★	★
	16NR-72UN	16NL-72UN	72	9.525	16	0.8	0.4	★	★	★	★
	16NR-64UN	16NL-64UN	64	9.525	16	0.8	0.4	★	★	★	★
	16NR-56UN	16NL-56UN	56	9.525	16	0.7	0.4	★	★	★	★
16NR-48UN	16NL-48UN	48	9.525	16	0.6	0.6	★	★	★	★	
16NR-44UN	16NL-44UN	44	9.525	16	0.6	0.6	★	★	★	★	

★Recommended grade ☆Optional grade ○Make to order

A

Common turning Parting and grooving

Thread insert

Thread insert

A

Common turning Parting and grooving

Thread insert



# Turning

Thread cutting tool  
Thread insert

## American UN

ASME B1.1-1989  
Tolerance class:2A/2B

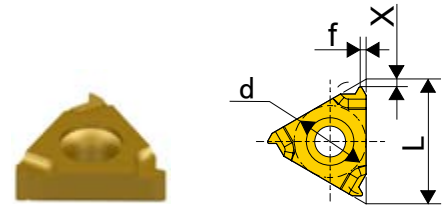
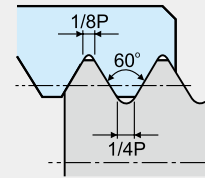

R type

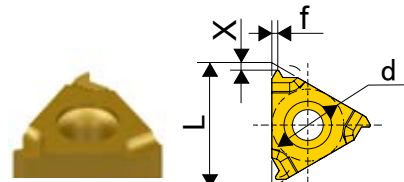

L type

Type	Oesignnation Right	Oesignnation Left	TPI	Dimensions(mm)				Recommended grade		Recommended grade	
				d	L	X	f	JT1025		JT1125	
								R	L	R	L
Internal	16NR-40UN	16NL-40UN	40	9.525	16	0.6	0.6	★	★	★	★
	16NR-36UN	16NL-36UN	36	9.525	16	0.6	0.6	★	★	★	★
	16NR-32UN	16NL-32UN	32	9.525	16	0.6	0.6	★	★	★	★
	16NR-28UN	16NL-28UN	28	9.525	16	0.6	0.7	★	★	★	★
	16NR-27UN	16NL-27UN	27	9.525	16	0.7	0.8	★	★	★	★
	16NR-24UN	16NL-24UN	24	9.525	16	0.7	0.8	★	★	★	★
	16NR-20UN	16NL-20UN	20	9.525	16	0.8	0.9	★	★	★	★
	16NR-18UN	16NL-18UN	18	9.525	16	0.8	1	★	★	★	★
	16NR-16UN	16NL-16UN	16	9.525	16	0.9	1.1	★	★	★	★
	16NR-14UN	16NL-14UN	14	9.525	16	1	1.2	★	★	★	★
	16NR-13UN	16NL-13UN	13	9.525	16	1	1.3	★	★	★	★
	16NR-12UN	16NL-12UN	12	9.525	16	1.1	1.4	★	★	★	★
	16NR-11.5UN	16NL-11.5UN	11.5	9.525	16	1.1	1.5	★	★	★	★
	16NR-11UN	16NL-11UN	11	9.525	16	1.1	1.5	★	★	★	★
	16NR-10UN	16NL-10UN	10	9.525	16	1.1	1.5	★	★	★	★
	16NR-9UN	16NL-9UN	9	9.525	16	1.2	1.7	★	★	★	★
	16NR-8UN	16NL-8UN	8	9.525	16	1.2	1.5	★	★	★	★
	22NR-7UN	22NL-7UN	7	12.7	22	1.6	2.3	★	★	★	★
	22NR-6UN	22NL-6UN	6	12.7	22	1.6	2.3	★	★	★	★
	22NR-5UN	22NL-5UN	5	12.7	22	1.7	2.3	★	★	★	★
27NR-4.5UN	27NL-4.5UN	4.5	15.875	27	1.9	2.4	★	★	★	★	
27NR-4UN	27NL-4UN	4	15.875	27	2.1	2.7	★	★	★	★	

★Recommended grade ☆Optional grade ○Make to order

Thread cutting tool  
Thread insert

# Turning

## Whit Worth

ISO 228/1:1982,  
DIN 259, B.S.84:1956  
Tolerance class:Medium class A

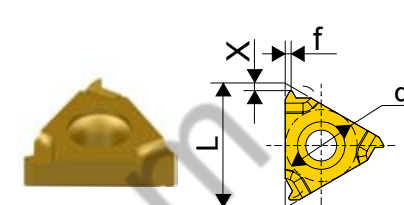
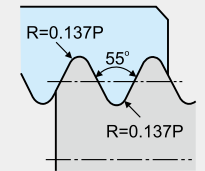

R type

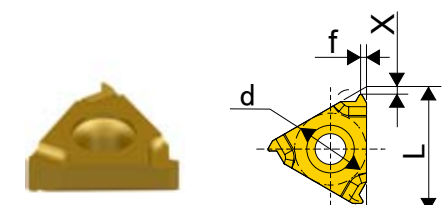

L type

Type	Oesignnation Right	Oesignnation Left	TPI	Dimensions(mm)				Recommended grade		Recommended grade	
				d	L	X	f	JT1025		JT1125	
								R	L	R	L
External	11ER-72W	11EL-72W	72	6.35	11	0.7	0.4	★	★	★	★
	11ER-64W	11EL-64W	64	6.35	11	0.7	0.4	★	★	★	★
	11ER-56W	11EL-56W	56	6.35	11	0.7	0.4	★	★	★	★
	11ER-48W	11EL-48W	48	6.35	11	0.6	0.6	★	★	★	★
	11ER-44W	11EL-44W	44	6.35	11	0.6	0.6	★	★	★	★
	11ER-40W	11EL-40W	40	6.35	11	0.6	0.6	★	★	★	★
	11ER-36W	11EL-36W	36	6.35	11	0.6	0.6	★	★	★	★
	11ER-32W	11EL-32W	32	6.35	11	0.6	0.6	★	★	★	★
	11ER-28W	11EL-28W	28	6.35	11	0.6	0.7	★	★	★	★
	11ER-26W	11EL-26W	27	6.35	11	0.7	0.8	★	★	★	★
	11ER-24W	11EL-24W	24	6.35	11	0.7	0.8	★	★	★	★
	11ER-22W	11EL-22W	24	6.35	11	0.8	0.9	★	★	★	★
	11ER-20W	11EL-20W	20	6.35	11	0.8	0.9	★	★	★	★
	11ER-19W	11EL-19W	19	6.35	11	0.8	1	★	★	★	★
	11ER-18W	11EL-18W	18	6.35	11	0.8	1	★	★	★	★
	11ER-16W	11EL-16W	16	6.35	11	0.9	1.1	★	★	★	★
	11ER-14W	11EL-14W	14	6.35	11	1	1.2	★	★	★	★
	16ER-72W	16EL-72W	72	9.525	16	0.7	0.4	★	★	★	★
	16ER-60W	16EL-60W	60	9.525	16	0.7	0.4	★	★	★	★
	16ER-56W	16EL-56W	56	9.525	16	0.7	0.4	★	★	★	★
16ER-48W	16EL-48W	48	9.525	16	0.6	0.6	★	★	★	★	
16ER-44W	16EL-44W	44	9.525	16	0.6	0.6	★	★	★	★	

★Recommended grade ☆Optional grade ○Make to order

# Turning

Thread cutting tool  
Thread insert

Whit Worth

ISO 228/1:1982,  
DIN 259, B.S.84:1956  
Tolerance class:Medium class A

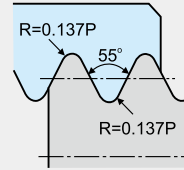

Type	Oesignnation Right	Oesignnation Left	TPI	Dimensions(mm)				Recommended grade		Recommended grade	
				d	L	X	f	JT1025		JT1125	
								R	L	R	L
External	16ER-40W	16EL-40W	40	9.525	16	0.6	0.6	★	★	★	★
	16ER-36W	16EL-36W	36	9.525	16	0.6	0.6	★	★	★	★
	16ER-32W	16EL-32W	32	9.525	16	0.6	0.6	★	★	★	★
	16ER-28W	16EL-28W	28	9.525	16	0.6	0.7	★	★	★	★
	16ER-26W	16EL-26W	26	9.525	16	0.7	0.8	★	★	★	★
	16ER-24W	16EL-24W	24	9.525	16	0.7	0.8	★	★	★	★
	16ER-22W	16EL-22W	22	9.525	16	0.7	0.8	★	★	★	★
	16ER-20W	16EL-20W	20	9.525	16	0.8	0.9	★	★	★	★
	16ER-18W	16EL-18W	18	9.525	16	0.8	1	★	★	★	★
	16ER-16W	16EL-16W	16	9.525	16	0.9	1.1	★	★	★	★
	16ER-14W	16EL-14W	14	9.525	16	1	1.2	★	★	★	★
	16ER-12W	16EL-12W	12	9.525	16	1.1	1.4	★	★	★	★
	16ER-11W	16EL-11W	11	9.525	16	1.1	1.5	★	★	★	★
	16ER-10W	16ENL-10W	10	9.525	16	1.1	1.5	★	★	★	★
	16ER-9W	16EL-9W	9	9.525	16	1.2	1.7	★	★	★	★
	16ER-8W	16NEL-8W	8	9.525	16	1.2	1.5	★	★	★	★
	22ER-7W	22EL-7W	7	12.7	22	1.6	2.3	★	★	★	★
	22ER-6W	22EL-6W	6	12.7	22	1.6	2.3	★	★	★	★
	22ER-5W	22EL-5W	5	12.7	22	1.7	2.4	★	★	★	★
	27ER-4.5W	27EL-4.5W	4.5	15.875	27	1.8	2.6	★	★	★	★
27ER-4UN	27EL-4UN	4	15.875	27	2.1	2.9	★	★	★	★	

★Recommended grade ☆Optional grade ○Make to order

Thread cutting tool  
Thread insert

# Turning

Whit Worth

ISO 228/1:1982,  
DIN 259, B.S.84:1956  
Tolerance class:Medium class A

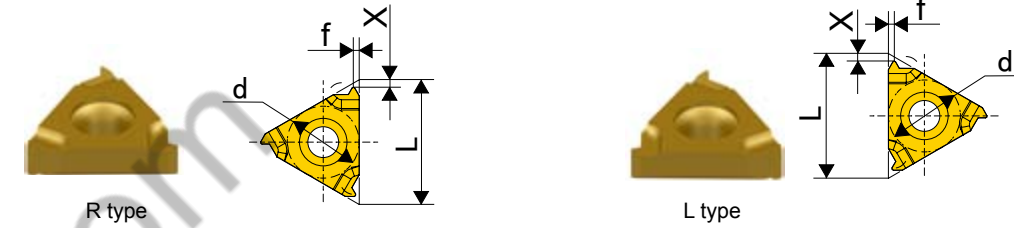
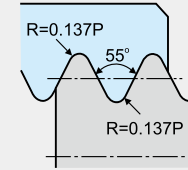

Type	Oesignnation Right	Oesignnation Left	TPI	Dimensions(mm)				Recommended grade		Recommended grade	
				d	L	X	f	JT1025		JT1125	
								R	L	R	L
Internal	11NR-72W	11NL-72W	72	6.35	11	0.7	0.4	★	★	★	★
	11NR-64W	11NL-64W	64	6.35	11	0.7	0.4	★	★	★	★
	11NR-56W	11NL-56W	56	6.35	11	0.7	0.4	★	★	★	★
	11NR-48W	11NL-48W	48	6.35	11	0.6	0.6	★	★	★	★
	11NR-40W	11N-40W	40	6.35	11	0.6	0.6	★	★	★	★
	11NR-36W	11NL-36W	36	6.35	11	0.6	0.6	★	★	★	★
	11NR-32W	11NL-32W	32	6.35	11	0.6	0.6	★	★	★	★
	11NR-28W	11NL-28W	28	6.35	11	0.6	0.7	★	★	★	★
	11NR-26W	11NL-26W	27	6.35	11	0.7	0.8	★	★	★	★
	11NR-24W	11NL-24W	24	6.35	11	0.7	0.8	★	★	★	★
	11NR-22W	11NL-22W	24	6.35	11	0.8	0.9	★	★	★	★
	11NR-20W	11NL-20W	20	6.35	11	0.8	0.9	★	★	★	★
	11NR-19W	11NL-19W	19	6.35	11	0.8	1	★	★	★	★
	11NR-18W	11NL-18W	18	6.35	11	0.8	1	★	★	★	★
	11NR-16W	11NL-16W	16	6.35	11	0.9	1.1	★	★	★	★
	11NR-14W	11NL-14W	14	6.35	11	0.9	1.1	★	★	★	★
	11NR-12W	11NL-12W	12	6.35	11	0.9	1.2	★	★	★	★
	16NR-72W	16NL-72W	72	9.525	16	0.7	0.4	★	★	★	★
	16NR-60W	16NL-60W	60	9.525	16	0.7	0.4	★	★	★	★
	16NR-56W	16NL-56W	56	9.525	16	0.7	0.4	★	★	★	★
16NR-48W	16NL-48W	48	9.525	16	0.6	0.6	★	★	★	★	
16NR-40W	16NL-40W	40	9.525	16	0.6	0.6	★	★	★	★	

★Recommended grade ☆Optional grade ○Make to order

A

Common turning Parting and grooving

Thread insert

A

Common turning Parting and grooving

Thread insert

# Turning

Thread cutting tool  
Thread insert

Whit Worth

ISO 228/1:1982,  
DIN 259, B.S.84:1956  
Tolerance class:Medium class A

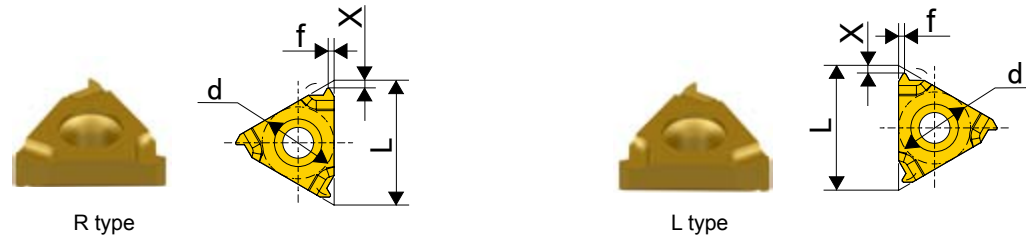
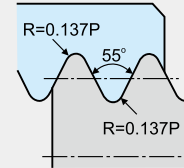

Type	Oesignnation Right	Oesignnation Left	TPI	Dimensions(mm)				Recommended grade		Recommended grade	
				d	L	X	f	JT1025		JT1125	
								R	L	R	L
Internal	16NR-36W	16NL-36W	36	9.525	16	0.6	0.6	★	★	★	★
	16NR-32W	16NL-32W	32	9.525	16	0.6	0.6	★	★	★	★
	16NR-30W	16NL-30W	30	9.525	16	0.6	0.7	★	★	★	★
	16NR-28W	16NL-28W	28	9.525	16	0.6	0.7	★	★	★	★
	16NR-26W	16NL-26W	26	9.525	16	0.7	0.8	★	★	★	★
	16NR-24W	16NL-24W	24	9.525	16	0.7	0.8	★	★	★	★
	16NR-22W	16NL-22W	22	9.525	16	0.8	0.9	★	★	★	★
	16NR-20W	16NL-20W	20	9.525	16	0.8	0.9	★	★	★	★
	16NR-19W	16NL-19W	20	9.525	16	0.8	1	★	★	★	★
	16NR-18W	16NL-18W	18	9.525	16	0.8	1	★	★	★	★
	16NR-16W	16NL-16W	16	9.525	16	0.9	1.1	★	★	★	★
	16NR-14W	16NL-14W	14	9.525	16	1	1.2	★	★	★	★
	16NR-12W	16NL-12W	12	9.525	16	1.1	1.4	★	★	★	★
	16NR-11W	16NL-11W	11	9.525	16	1.1	1.5	★	★	★	★
	16NR-10W	16NL-10W	10	9.525	16	1.1	1.5	★	★	★	★
	16NR-9W	16NL-9W	9	9.525	16	1.2	1.7	★	★	★	★
	16NR-8W	16NL-8W	8	9.525	16	1.2	1.5	★	★	★	★
	22NR-7W	22NL-7W	7	12.7	22	1.6	2.3	★	★	★	★
	22NR-6W	22NL-6W	6	12.7	22	1.6	2.3	★	★	★	★
	22NR-5W	22NL-5W	5	12.7	22	1.7	2.4	★	★	★	★
27NR-4.5W	27NL-4.5W	4.5	15.875	27	1.8	2.6	★	★	★	★	
27NR-4W	27NL-4W	4	15.875	27	2.1	2.9	★	★	★	★	

★Recommended grade ☆Optional grade ○Make to order

# Turning

Thread cutting tool  
Thread insert

British Standard Thread

ISO 7/1:1994  
B.S.21:1985  
Standard BSPT

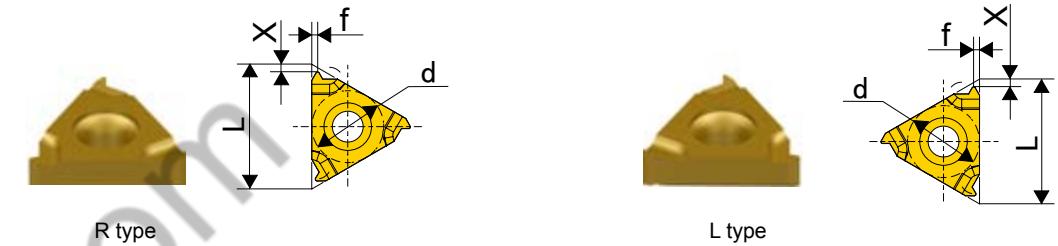
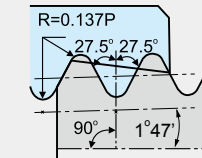

Type	Oesignnation Right	Oesignnation Left	TPI	Dimensions(mm)				Recommended grade		Recommended grade	
				d	L	X	f	JT1025		JT1125	
								R	L	R	L
External	11ER-28BSPT	11NL-28BSPT	28	6.35	11	0.6	0.6	★	★	★	★
	11ER-19BSPT	11NL-28BSPT	19	6.35	11	0.8	0.9	★	★	★	★
	11ER-14BSPT	11NL-14BSPT	14	6.35	11	0.9	1	★	★	★	★
	16ER-28BSPT	16NL-28BSPT	28	9.525	16	0.6	0.6	★	★	★	★
	16ER-19BSPT	16NL-19BSPT	19	9.525	16	0.8	0.9	★	★	★	★
	16ER-14BSPT	16NL-14BSPT	14	9.525	16	1	1.2	★	★	★	★
	16ER-11BSPT	11NL-11BSPT	11	9.525	16	1.1	1.5	★	★	★	★

★Recommended grade ☆Optional grade ○Make to order



Type	Oesignnation Right	Oesignnation Left	TPI	Dimensions(mm)				Recommended grade		Recommended grade	
				d	L	X	f	JT1025		JT1125	
								R	L	R	L
Internal	11NR-28BSPT	11NL-28BSPT	28	6.35	11	0.6	0.6	★	★	★	★
	11NR-19BSPT	11NL-28BSPT	19	6.35	11	0.8	0.9	★	★	★	★
	11NR-14BSPT	11NL-14BSPT	14	6.35	11	0.9	1	★	★	★	★
	16NR-28BSPT	16NL-28BSPT	28	9.525	16	0.6	0.6	★	★	★	★
	16NR-19BSPT	16NL-19BSPT	19	9.525	16	0.8	0.9	★	★	★	★
	16NR-14BSPT	16NL-14BSPT	14	9.525	16	1	1.2	★	★	★	★
	16NR-11BSPT	11NL-11BSPT	11	9.525	16	1.1	1.5	★	★	★	★

★Recommended grade ☆Optional grade ○Make to order

A

Common turning Parting and grooving

Thread insert

A

Common turning Parting and grooving

Thread insert

Thread insert

# Turning

Thread cutting tool  
Thread insert

## American 60°tape pipe thread

ASME B1.20.1-1983  
Standard NPT

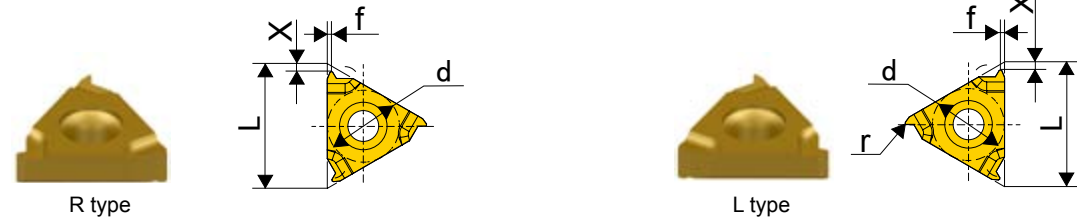
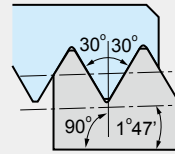

Type	Oesignnation Right	Oesignnation Left	TPI	Dimensions(mm)				Recommended grade		Recommended grade	
				d	L	X	f	JT1025		JT1125	
								R	L	R	L
External	11ER-27NPT	11EL-27NPT	27	6.35	11	0.7	0.8	★	★	★	★
	11ER-18NPT	11EL-18NPT	18	6.35	11	0.8	1	★	★	★	★
	11ER-14NPT	11EL-14NPT	14	6.35	11	0.8	1	★	★	★	★
	16ER-28NPT	16EL-28NPT	28	9.525	16	0.7	0.8	★	★	★	★
	16ER-18NPT	16EL-18NPT	18	9.525	16	0.8	1	★	★	★	★
	16ER-14NPT	16EL-14NPT	14	9.525	16	0.9	1.2	★	★	★	★
	16ER-11.5NPT	11EL-11.5NPT	11.5	9.525	16	1.1	1.5	★	★	★	★
	16ER-8NPT	11EL-8NPT	8	9.525	16	1.3	1.8	★	★	★	★

★Recommended grade ☆Optional grade ○Make to order

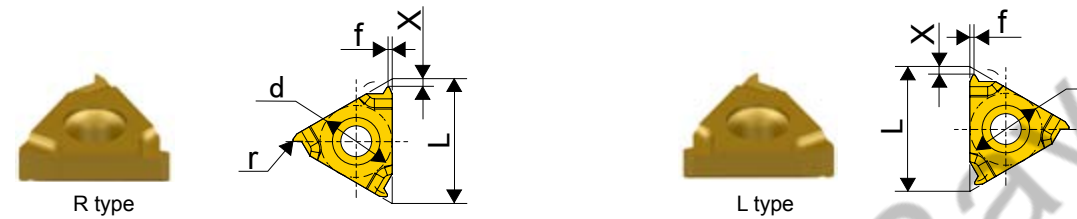

Type	Oesignnation Right	Oesignnation Left	TPI	Dimensions(mm)				Recommended grade		Recommended grade	
				d	L	X	f	JT1025		JT1125	
								R	L	R	L
Internal	11NR-27NPT	11NL-27NPT	27	6.35	11	0.7	0.8	★	★	★	★
	11NR-18NPT	11NL-18NPT	18	6.35	11	0.8	1	★	★	★	★
	11NR-14NPT	11NL-14NPT	14	6.35	11	0.8	1	★	★	★	★
	16NR-28NPT	16NL-28NPT	28	9.525	16	0.7	0.8	★	★	★	★
	16NR-18NPT	16NL-18NPT	18	9.525	16	0.8	1	★	★	★	★
	16NR-14NPT	16NL-14NPT	14	9.525	16	0.9	1.2	★	★	★	★
	16NR-11.5NPT	11NL-11.5NPT	11.5	9.525	16	1.1	1.5	★	★	★	★
	16NR-8NPT	11NL-8NPT	8	9.525	16	1.3	1.8	★	★	★	★

★Recommended grade ☆Optional grade ○Make to order

Thread cutting tool  
Thread insert

# Turning

## NPTF National Pipe Thread-Dry seal

NPTF60°  
Standard:ANSI B1.20.1-1983  
Tolerance class:2G

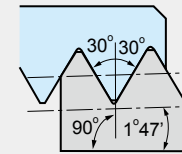

Type	Oesignnation Right	Oesignnation Left	TPI	Dimensions(mm)				Recommended grade		Recommended grade	
				d	L	X	f	JT1025		JT1125	
								R	L	R	L
External	11ER-27NPTF	11EL-27NPTF	27	6.35	11	0.7	0.8	★	★	★	★
	11ER-18NPTF	11EL-18NPTF	18	6.35	11	0.8	1	★	★	★	★
	11ER-14NPTF	11EL-14NPTF	14	6.35	11	0.8	1	★	★	★	★
	16ER-28NPTF	16EL-28NPTF	28	9.525	16	0.7	0.8	★	★	★	★
	16ER-18NPTF	16EL-18NPTF	18	9.525	16	0.8	1	★	★	★	★
	16ER-14NPTF	16EL-14NPTF	14	9.525	16	0.9	1.2	★	★	★	★
	16ER-11.5NPTF	11EL-11.5NPTF	11.5	9.525	16	1.1	1.5	★	★	★	★
	16ER-8NPTF	11EL-8NPTF	8	9.525	16	1.3	1.8	★	★	★	★

★Recommended grade ☆Optional grade ○Make to order

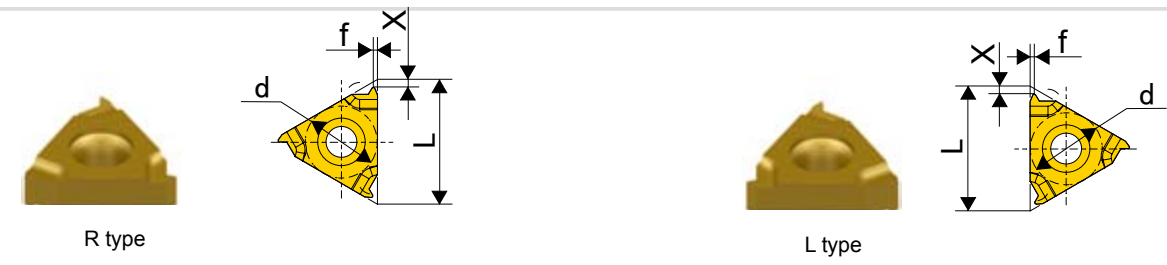

Type	Oesignnation Right	Oesignnation Left	TPI	Dimensions(mm)				Recommended grade		Recommended grade	
				d	L	X	f	JT1025		JT1125	
								R	L	R	L
Internal	11NR-27NPTF	11NL-27NPTF	27	6.35	11	0.7	0.8	★	★	★	★
	11NR-18NPTF	11NL-18NPTF	18	6.35	11	0.8	1	★	★	★	★
	11NR-14NPTF	11NL-14NPTF	14	6.35	11	0.8	1	★	★	★	★
	16NR-28NPTF	16NL-28NPTF	28	9.525	16	0.7	0.8	★	★	★	★
	16NR-18NPTF	16NL-18NPTF	18	9.525	16	0.8	1	★	★	★	★
	16NR-14NPTF	16NL-14NPTF	14	9.525	16	0.9	1.2	★	★	★	★
	16NR-11.5NPTF	11NL-11.5NPTF	11.5	9.525	16	1.1	1.5	★	★	★	★
	16NR-8NPTF	11NL-8NPTF	8	9.525	16	1.3	1.8	★	★	★	★

★Recommended grade ☆Optional grade ○Make to order

A

Common turning Parting and grooving

Thread insert

Thread insert

A

Common turning Parting and grooving

Thread insert

Thread insert



# Turning

Thread cutting tool  
Thread insert

## Round DIN405

DIN 405  
Tolerance class:7G

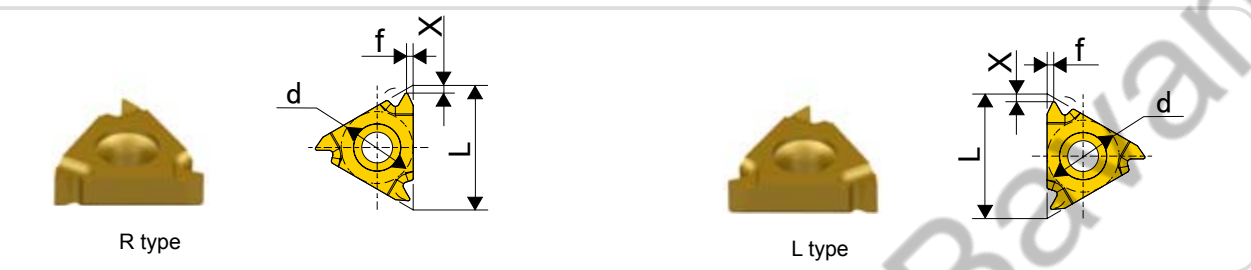
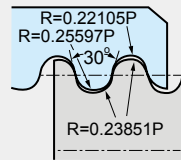

Type	Oesignnation Right	Oesignnation Left	TPI	Dimensions(mm)				Recommended grade			
				d	L	X	f	JT1025		JT1125	
								R	L	R	L
Internal	16ER-10RD	16EL-10RD	10	9.525	16	1.1	1.2	★	★	★	★
	16ER-8RD	16EL-8RD	8	9.525	16	1.4	1.3	★	★	★	★
	16ER-6RD	16EL-6RD	6	9.525	16	1.5	1.7	★	★	★	★
	22ER-6RD	22ER-6RD	6	12.7	22	1.5	1.7	★	★	★	★
	22ER-4RD	22ER-4RD	4	12.7	22	2.2	2.3	★	★	★	★
	27ER-4RD	27ER-4RD	4	15.875	27	2.2	2.3	★	★	★	★

★Recommended grade ☆Optional grade ○Make to order

# Turning

Thread cutting tool  
Thread insert

## Trapez DIN103

ISO 2901-2904  
Tolerance class:7G

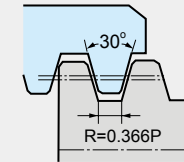

Type	Oesignnation Right	Oesignnation Left	TPI	Dimensions(mm)				Recommended grade			
				d	L	X	f	JT1025		JT1125	
								R	L	R	L
External	11ER-1.5TR	11EL-1.5TR	1.5	6.35	11	0.8	0.9	★	★	★	★
	16ER-1.5TR	16EL-1.5TR	1.5	9.525	16	1	1.1	★	★	★	★
	16ER-2.0TR	16EL-2.0TR	2	9.525	16	1.1	1.3	★	★	★	★
	16ER-3.0TR	16EL-3.0TR	3	9.525	16	1.3	1.5	★	★	★	★
	22ER-4.0TR	22EL-4.0TR	4	12.7	22	1.7	1.9	★	★	★	★
	22ER-5.0TR	22EL-5.0TR	5	12.7	22	2.1	2.5	★	★	★	★
27ER-6.0TR	27ER-6.0TR	6	15.875	27	2.3	2.7	★	★	★	★	

★Recommended grade ☆Optional grade ○Make to order



Type	Oesignnation Right	Oesignnation Left	TPI	Dimensions(mm)				Recommended grade			
				d	L	X	f	JT1025		JT1125	
								R	L	R	L
Internal	11NR-1.5TR	11NL-1.5TR	1.5	6.35	11	0.8	0.9	★	★	★	★
	16NR-1.5TR	16NL-1.5TR	1.5	9.525	16	1	1.1	★	★	★	★
	16NR-2.0TR	16NL-2.0TR	2	9.525	16	1.1	1.3	★	★	★	★
	16NR-3.0TR	16NL-3.0TR	3	9.525	16	1.3	1.5	★	★	★	★
	22NR-4.0TR	22NL-4.0TR	4	12.7	22	1.7	1.9	★	★	★	★
	22NR-5.0TR	22NL-5.0TR	5	12.7	22	2.1	2.5	★	★	★	★
27NR-6.0TR	27NR-6.0TR	6	15.875	27	2.3	2.7	★	★	★	★	

★Recommended grade ☆Optional grade ○Make to order

# Turning

Thread cutting tool  
Thread insert

## American trapez 29° thread

ANSI B1.5-1988 ANSI B1.5-1988  
Tolerance class: 2G

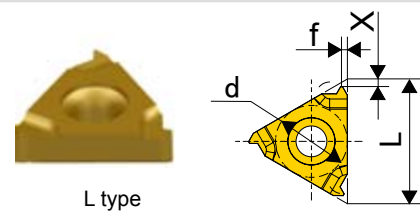
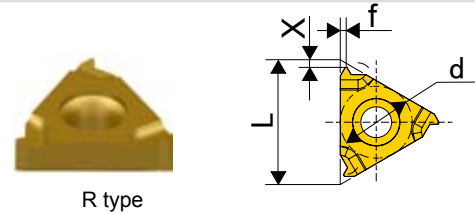
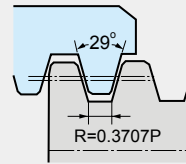

Type	Designation Right	Designation Left	TPI	Dimensions(mm)				Recommended grade		Recommended grade	
				d	L	X	f	JT1025	JT1125	JT1025	JT1125
External	11ER-16ACME	11EL-16ACMT	16	6.35	11	1	1.1	★	★	★	★
	16ER-16ACME	16EL-16ACME	16	9.525	16	1	1.1	★	★	★	★
	16ER-14ACME	16EL-14ACME	14	9.525	16	1	1.2	★	★	★	★
	16ER-12ACME	16EL-12ACME	12	9.525	16	1.1	1.2	★	★	★	★
	16ER-10ACME	16EL-10ACME	10	9.525	16	1.3	1.4	★	★	★	★
	16ER-8CME	16EL-8ACME	8	9.525	16	1.4	1.5	★	★	★	★
	16ER-6ACME	16EL-6ACME	6	9.525	16	1.7	1.9	★	★	★	★
	22ER-6ACME	22EL-6ACME	6	12.7	22	1.8	2.1	★	★	★	★
	22ER-5ACME	22EL-5ACME	5	12.7	22	2	2.3	★	★	★	★
27ER-4ACME	27EL-4ACME	4	15.875	27	2.4	2.7	★	★	★	★	

★Recommended grade ☆Optional grade ○Make to order

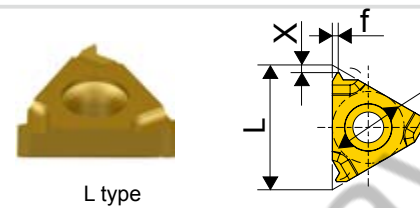
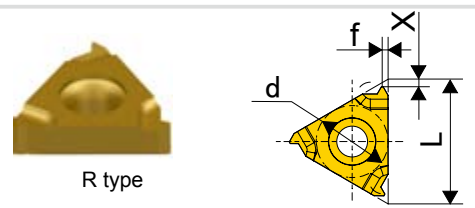

Type	Designation Right	Designation Left	TPI	Dimensions(mm)				Recommended grade		Recommended grade	
				d	L	X	f	JT1025	JT1125	JT1025	JT1125
Internal	11NR-16ACME	11NL-16ACMT	16	6.35	11	1	1.1	★	★	★	★
	16NR-16ACME	16NL-16ACME	16	9.525	16	1	1.1	★	★	★	★
	16NR-14ACME	16NL-14ACME	14	9.525	16	1	1.2	★	★	★	★
	16NR-12ACME	16NL-12ACME	12	9.525	16	1.1	1.2	★	★	★	★
	16NR-10ACME	16NL-10ACME	10	9.525	16	1.3	1.4	★	★	★	★
	16NR-8CME	16NL-8ACME	8	9.525	16	1.4	1.5	★	★	★	★
	16NR-6ACME	16NL-6ACME	6	9.525	16	1.7	1.9	★	★	★	★
	22NR-6ACME	22NL-6ACME	6	12.7	22	1.8	2.1	★	★	★	★
	22NR-5ACME	22NL-5ACME	5	12.7	22	2	2.3	★	★	★	★
27NR-4ACME	27NL-4ACME	4	15.875	27	2.3	2.6	★	★	★	★	

★Recommended grade ☆Optional grade ○Make to order

Thread cutting tool  
Thread insert

# Turning

## Thread toolholder naming rules

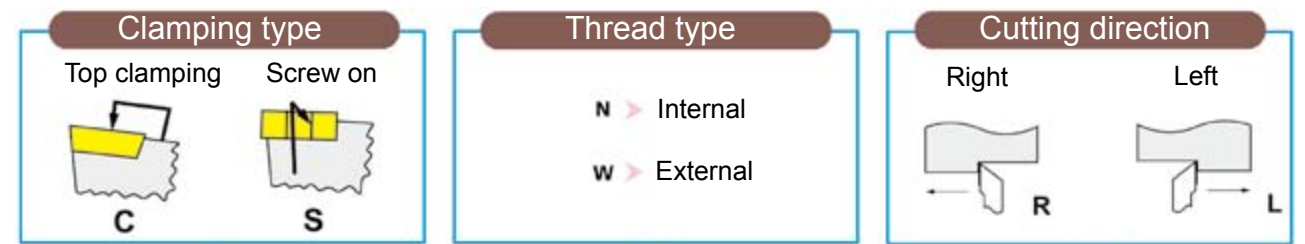

**S W R 20 20 K 16**

### Nose height(mm)



Note: Round holder is represented by 00.  
Marked only integer, for example: h=8mm, labeled 08.

### Width of tool(mm)



Note: Round holder is represented by diameter.  
for example: b=8mm, labeled 08.

### Length of toolholder(mm)

Code	H	K	M	P	Q	R	S	T	U
Length	100	125	150	170	180	200	250	300	350

### Size of insert(mm)

Code	11	16	22	27
Length of triangle	11	16	22	27
Inscribed circle	6.35	9.525	12.70	15.875

A

Common turning Parting and grooving

Thread insert

Thread insert

A

Common turning Parting and grooving

Thread insert

Thread insert

In order to obtain the best thread processing effect, please follow the steps below:

- 1 Choosing the right thread processing way.
- 2 Choose helix angle, choose shim.
- 3 Choose the appropriate insert and size of toolholder.
- 4 Reference standard thread processing programming parameter table, choose appropriate cutting data.
- 5 Choose feed method.

### Machine type of thread tool

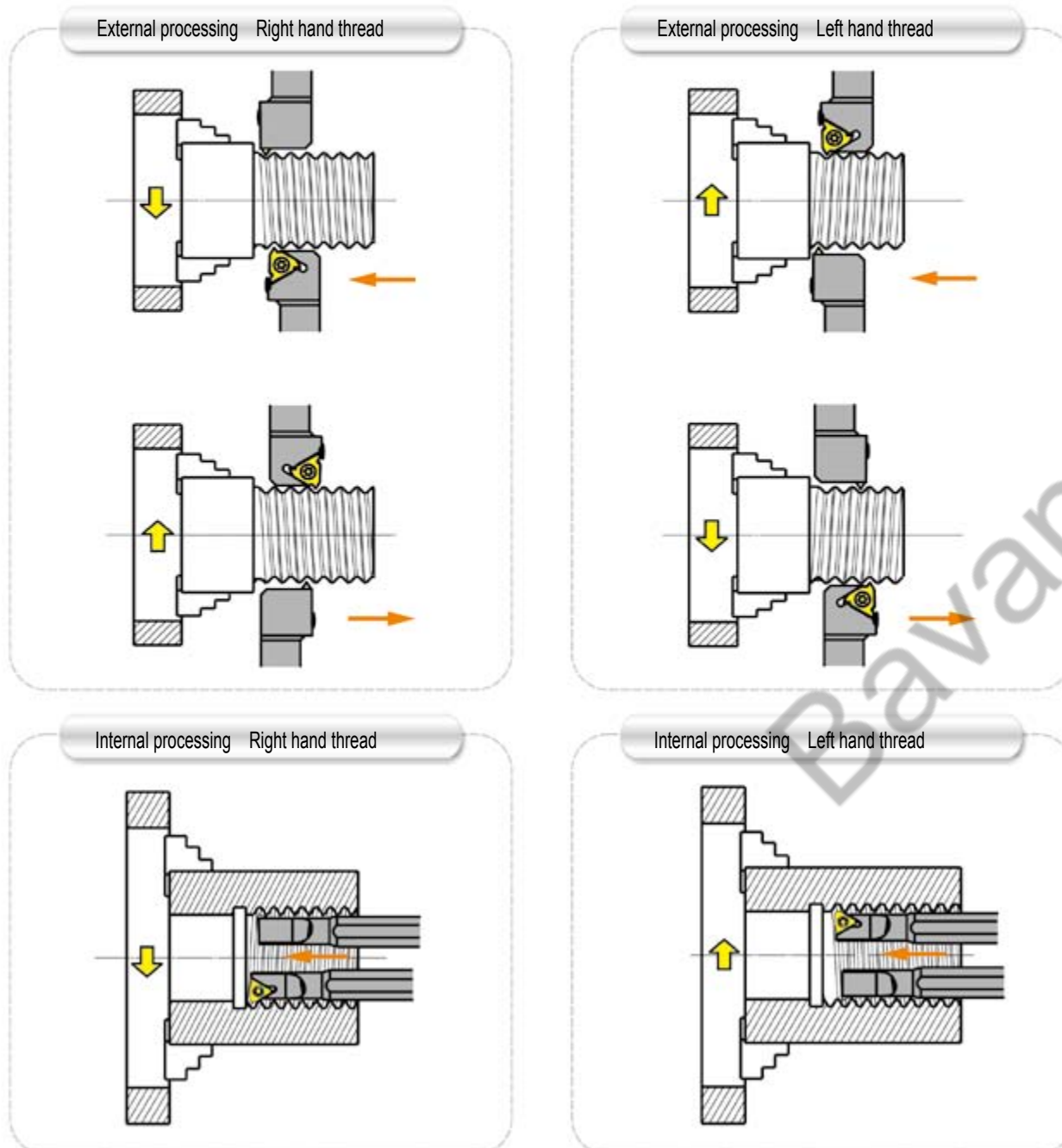

### Choose helix angle and shim

The clearance angle of thread mainly along the edge of tool. This will significantly impact on heat dissipation, tool wear extension, tool life, production safety, the quality of the thread. The clearance angle of thread profile depend on the helix angle, because both are similar. If inclined angle different from helix angle, and the clearance angle is changed.

The inclined angle must be the same as helix angle to avoid excessive wear and lead to shorten the tool life. Helix angle is calculated by the following formula:

$$\rho = \arctan \frac{P}{d_2 \times \pi}$$

P=Pitch  
 $d_2$ =Pitch diameter  
 Common inclined angle is 1°, MT standard shim inclined angle is 1°.  
 Calculation of clearance angle:  
 The clearance angle is calculated by the following formula:

$$\beta = \arcsin(\tan \theta \times \tan \alpha)$$

$2\theta$  = Thread profile angle  
 $\alpha$  = Rake angle, external is 10°, internal is 15° for standard tool

If helix angle  $\leq$  clearance angle, the side insert can produce interference, must be replace the shim. Please adjust the difference between helix angle and inclined angle to 2°-0° through replace the shim.

Ex: if P=1.5,  $d_2=24$ mm  
 Helix angle  $1.14^\circ - (2^\circ - 0^\circ) = \text{Inclined } (-0.86^\circ \sim 1.14^\circ)$   
 Choose standard shim 1° to processe.

Pitch	Size	Inclined angle	Shim
0.5-3.0	16	0	MT16-00M
		1	MT16-01M
		2	MT16-02M
		3	MT16-03M
3.5-6.0	22	0	MT22-00M
		1	MT22-01M
		2	MT22-02M
		3	MT22-03M

(MT16-01M or MT22-01M)

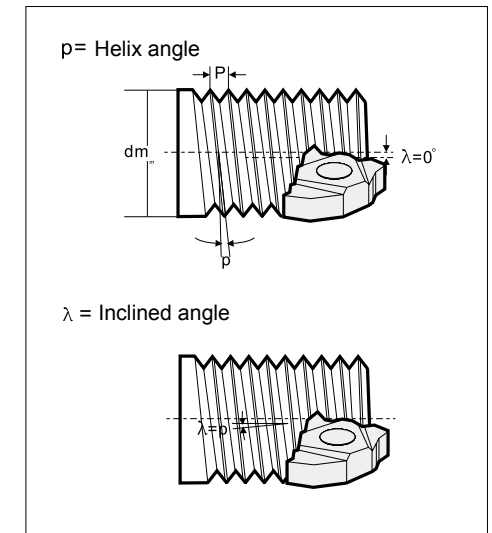

Thread profile	$2\theta$	$\beta$	
		External	Internal
60°		8.5°	6°
55°		7°	7°
30°		4°	2.5°
29°		4°	2.5°

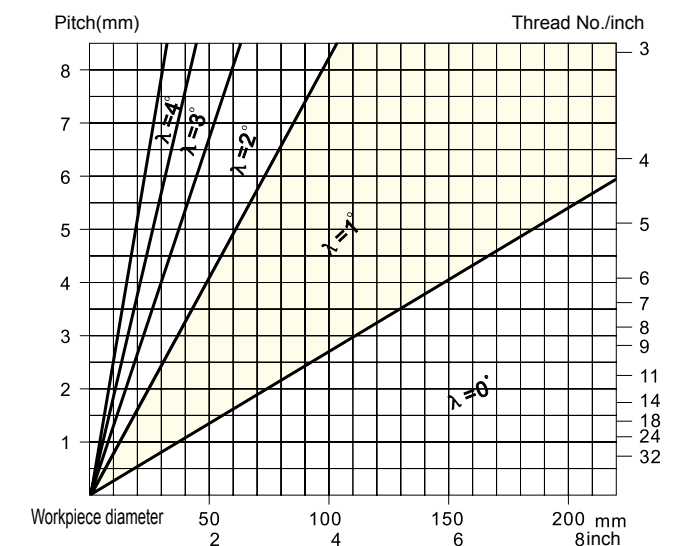

# Turning

## Thread cutting tool

Thread processing applications data

Choose appropriate insert and size of toolholder(reference the list of thread turning tool)

Different standard thread processing programming parameter table

■ Metric ISO External thread with wiper feed quantity recommend table

Pitch	1.0	1.25	1.5	1.75	2.0	2.5	3.0	4.0	5.0
The total amount of feed	<b>0.72</b>	<b>0.86</b>	<b>1.02</b>	<b>1.17</b>	<b>1.33</b>	<b>1.63</b>	<b>1.94</b>	<b>2.58</b>	<b>3.21</b>
Feed time	<b>5</b>	<b>6</b>	<b>7</b>	<b>8</b>	<b>9</b>	<b>11</b>	<b>13</b>	<b>15</b>	<b>17</b>
Tool moving styles	Radial feed(X)and tooth side feed(Z)								
	x/z	x/z	x/z	x/z	x/z	x/z	x/z	x/z	x/z
1	0.20/-	0.20/-	0.21/-	0.22/-	0.24/-	0.25/-	0.26/-	0.35/-	0.40/-
2	0.18/0.10	0.18/0.10	0.18/0.10	0.20/0.12	0.22/0.13	0.24/0.14	0.24/0.14	0.30/0.17	0.35/0.20
3	0.16/0.09	0.16/0.09	0.18/0.10	0.18/0.10	0.20/0.12	0.21/0.12	0.20/0.12	0.25/0.14	0.30/0.17
4	0.10/0.06	0.14/0.09	0.15/0.09	0.15/0.09	0.15/0.09	0.18/0.10	0.20/0.12	0.20/0.12	0.28/0.16
5	0.08/-	0.10/0.06	0.12/0.07	0.13/0.08	0.12/0.07	0.15/0.09	0.18/0.10	0.18/0.10	0.25/0.14
6		0.08/-	0.10/0.06	0.11/0.06	0.12/0.07	0.12/0.07	0.15/0.09	0.18/0.10	0.20/0.12
7			0.08/-	0.10/0.06	0.10/0.06	0.12/0.07	0.13/0.08	0.16/0.09	0.18/0.10
8				0.08/-	0.10/0.06	0.10/0.06	0.12/0.07	0.15/0.09	0.16/0.09
9					0.08/-	0.10/0.06	0.10/0.06	0.15/0.09	0.15/0.09
10						0.08/0.05	0.10/0.06	0.13/0.08	0.15/0.09
11							0.08/-	0.10/0.06	0.12/0.07
12								0.08/0.06	0.12/0.07
13									0.08/0.06
14									0.10/0.06
15									0.08/-
16									0.10/0.06
17									0.08/-

# Turning

Thread processing applications data

■ Metric ISO Internal thread with wiper feed quantity recommend table

Pitch	1.00	1.25	1.5	1.75	2.0	2.5	3.0	4.0	5.0
The total amount of feed	<b>0.62</b>	<b>0.77</b>	<b>0.92</b>	<b>1.06</b>	<b>1.21</b>	<b>1.49</b>	<b>1.79</b>	<b>2.36</b>	<b>2.95</b>
Feed time	<b>5</b>	<b>6</b>	<b>7</b>	<b>8</b>	<b>9</b>	<b>11</b>	<b>13</b>	<b>15</b>	<b>17</b>
Tool moving styles	Radial feed(X)and tooth side feed(Z)								
	x/z	x/z	x/z	x/z	x/z	x/z	x/z	x/z	x/z
1	0.18/-	0.20/-	0.22/-	0.23/-	0.24/-	0.25/-	0.26/-	0.30/-	0.32/-
2	0.14/0.08	0.15/0.09	0.16/0.09	0.16/0.09	0.18/0.10	0.20/0.12	0.20/0.12	0.25/0.14	0.28/0.16
3	0.12/0.07	0.12/0.07	0.14/0.08	0.14/0.08	0.15/0.09	0.15/0.09	0.20/0.12	0.22/0.13	0.25/0.14
4	0.10/0.06	0.12/0.07	0.12/0.07	0.13/0.08	0.14/0.08	0.15/0.09	0.18/0.10	0.20/0.12	0.22/0.13
5	0.08/-	0.10/0.06	0.11/0.06	0.12/0.07	0.12/0.07	0.13/0.08	0.15/0.09	0.18/0.10	0.21/0.12
6		0.08/-	0.09/0.05	0.10/0.06	0.11/0.06	0.12/0.07	0.12/0.07	0.15/0.09	0.20/0.12
7			0.08/-	0.10/0.06	0.10/0.06	0.12/0.07	0.12/0.07	0.15/0.09	0.18/0.10
8				0.08/-	0.09/0.05	0.10/0.06	0.10/0.06	0.15/0.09	0.18/0.10
9					0.08/-	0.10/0.06	0.10/0.06	0.12/0.07	0.15/0.09
10						0.09/0.05	0.10/0.06	0.12/0.07	0.15/0.09
11							0.08/-	0.10/0.06	0.12/0.07
12								0.08/0.05	0.11/0.06
13									0.08/-
14									0.10/0.06
15									0.08/-
16									0.10/0.06
17									0.08/-

A

Common turning, Parting and grooving

Thread insert

Thread processing applications data

A

Common turning, Parting and grooving

Thread insert

Thread processing applications data



# Turning

## Thread cutting tool

Thread processing applications data

American UN External thread feed quantity recommend table

Pitch	24	20	18	16	14	12	11	10	9	8	7	6	5
The total amount of feed	<b>0.649</b>	<b>0.779</b>	<b>0.866</b>	<b>0.974</b>	<b>1.113</b>	<b>1.299</b>	<b>1.416</b>	<b>1.558</b>	<b>1.731</b>	<b>1.948</b>	<b>2.226</b>	<b>2.597</b>	<b>3.116</b>
Feed time	5	6	6	7	9	9	10	11	12	13	14	15	16
Tool moving styles	Radial feed(X)and tooth side feed(Z)												
	x/z	x/z	x/z	x/z	x/z	x/z	x/z	x/z	x/z	x/z	x/z	x/z	x/z
1	0.206 / 0.086	0.210 / 0.094	0.233 / 0.104	0.226 / 0.109	0.196 / 0.110	0.229 / 0.128	0.220 / 0.132	0.214 / 0.139	0.210 / 0.148	0.211 / 0.160	0.213 / 0.176	0.218 / 0.198	0.229 / 0.230
2	0.148 / 0.086	0.163 / 0.094	0.181 / 0.104	0.188 / 0.109	0.189 / 0.110	0.222 / 0.128	0.228 / 0.132	0.240 / 0.139	0.256 / 0.148	0.276 / 0.160	0.304 / 0.176	0.343 / 0.198	0.399 / 0.230
3	0.114 / 0.066	0.125 / 0.072	0.139 / 0.080	0.145 / 0.083	0.146 / 0.084	0.170 / 0.098	0.176 / 0.102	0.184 / 0.106	0.196 / 0.113	0.212 / 0.122	0.234 / 0.135	0.263 / 0.152	0.306 / 0.177
4	0.096 / 0.055	0.105 / 0.061	0.117 / 0.068	0.122 / 0.070	0.123 / 0.071	0.143 / 0.083	0.148 / 0.086	0.155 / 0.090	0.165 / 0.095	0.179 / 0.103	0.197 / 0.114	0.222 / 0.128	0.258 / 0.149
5	0.085 / 0.049	0.093 / 0.054	0.103 / 0.059	0.107 / 0.062	0.108 / 0.062	0.126 / 0.073	0.131 / 0.075	0.137 / 0.079	0.146 / 0.084	0.158 / 0.091	0.173 / 0.100	0.195 / 0.113	0.227 / 0.131
6		0.084 / 0.048	0.093 / 0.054	0.097 / 0.056	0.098 / 0.056	0.114 / 0.066	0.118 / 0.068	0.124 / 0.072	0.132 / 0.076	0.142 / 0.082	0.157 / 0.091	0.177 / 0.102	0.205 / 0.119
7				0.089 / 0.052	0.090 / 0.052	0.105 / 0.061	0.109 / 0.063	0.114 / 0.066	0.121 / 0.070	0.131 / 0.076	0.144 / 0.083	0.163 / 0.094	0.189 / 0.109
8					0.084 / 0.048	0.098 / 0.056	0.101 / 0.058	0.106 / 0.061	0.113 / 0.065	0.122 / 0.070	0.134 / 0.078	0.151 / 0.087	0.176 / 0.101
9						0.079 / 0.045	0.092 / 0.053	0.095 / 0.055	0.100 / 0.057	0.106 / 0.061	0.114 / 0.066	0.126 / 0.073	0.165 / 0.095
10							0.090 / 0.052	0.094 / 0.054	0.100 / 0.058	0.108 / 0.063	0.119 / 0.069	0.134 / 0.078	0.156 / 0.090
11								0.090 / 0.052	0.095 / 0.055	0.103 / 0.059	0.113 / 0.065	0.128 / 0.074	0.149 / 0.086
12									0.091 / 0.053	0.098 / 0.057	0.108 / 0.063	0.122 / 0.071	0.142 / 0.082
13										0.094 / 0.054	0.104 / 0.060	0.117 / 0.068	0.136 / 0.079
14											0.100 / 0.058	0.113 / 0.065	0.131 / 0.076
15												0.109 / 0.063	0.126 / 0.073
16													0.122 / 0.071

# Turning

Thread processing applications data

American UN Internal thread feed quantity recommend table

Pitch	24	20	18	16	14	12	11	10	9	8	7	6	5
The total amount of feed	<b>0.573</b>	<b>0.687</b>	<b>0.764</b>	<b>0.860</b>	<b>0.982</b>	<b>1.146</b>	<b>1.250</b>	<b>1.375</b>	<b>1.528</b>	<b>1.719</b>	<b>1.964</b>	<b>2.291</b>	<b>2.750</b>
Feed time	5	6	6	7	8	9	9	10	11	12	13	14	15
Tool moving styles	Radial feed(X)and tooth side feed(Z)												
	x/z	x/z	x/z	x/z	x/z	x/z	x/z	x/z	x/z	x/z	x/z	x/z	x/z
1	0.193 / 0.073	0.200 / 0.081	0.222 / 0.089	0.219 / 0.093	0.220 / 0.100	0.228 / 0.110	0.250 / 0.120	0.247 / 0.125	0.246 / 0.132	0.252 / 0.142	0.262 / 0.156	0.278 / 0.176	0.302 / 0.204
2	0.127 / 0.073	0.239 / 0.081	0.155 / 0.089	0.161 / 0.093	0.173 / 0.100	0.190 / 0.110	0.207 / 0.120	0.216 / 0.125	0.229 / 0.132	0.247 / 0.142	0.271 / 0.156	0.304 / 0.176	0.353 / 0.204
3	0.098 / 0.056	0.107 / 0.062	0.119 / 0.069	0.124 / 0.072	0.132 / 0.076	0.146 / 0.084	0.159 / 0.092	0.166 / 0.096	0.176 / 0.101	0.189 / 0.109	0.208 / 0.120	0.234 / 0.135	0.271 / 0.156
4	0.082 / 0.048	0.090 / 0.052	0.100 / 0.058	0.104 / 0.060	0.112 / 0.064	0.123 / 0.071	0.134 / 0.077	0.140 / 0.081	0.148 / 0.086	0.160 / 0.092	0.175 / 0.101	0.197 / 0.114	0.228 / 0.132
5	0.073 / 0.042	0.079 / 0.046	0.088 / 0.051	0.092 / 0.053	0.098 / 0.057	0.108 / 0.062	0.118 / 0.068	0.123 / 0.071	0.130 / 0.075	0.141 / 0.081	0.1543 / 0.089	0.173 / 0.100	0.201 / 0.116
6		0.072 / 0.041	0.080 / 0.046	0.083 / 0.048	0.089 / 0.051	0.098 / 0.056	0.107 / 0.062	0.111 / 0.064	0.118 / 0.068	0.127 / 0.073	0.140 / 0.081	0.157 / 0.091	0.182 / 0.105
7				0.077 / 0.044	0.082 / 0.047	0.090 / 0.052	0.098 / 0.057	0.102 / 0.059	0.108 / 0.063	0.117 / 0.067	0.128 / 0.074	0.144 / 0.083	0.167 / 0.097
8					0.076 / 0.044	0.084 / 0.048	0.091 / 0.053	0.095 / 0.055	0.101 / 0.058	0.109 / 0.063	0.119 / 0.069	0.134 / 0.078	0.156 / 0.090
9						0.079 / 0.045	0.086 / 0.050	0.090 / 0.052	0.095 / 0.055	0.102 / 0.059	0.112 / 0.065	0.126 / 0.073	0.146 / 0.084
10								0.085 / 0.049	0.090 / 0.052	0.097 / 0.056	0.106 / 0.061	0.119 / 0.069	0.138 / 0.080
11									0.085 / 0.049	0.092 / 0.053	0.101 / 0.058	0.113 / 0.065	0.131 / 0.076
12										0.088 / 0.051	0.096 / 0.056	0.108 / 0.063	0.126 / 0.073
13											0.092 / 0.053	0.101 / 0.060	0.121 / 0.070
14												0.100 / 0.058	0.116 / 0.067
15													0.112 / 0.065

A

Common turning Parting and grooving

Thread insert

Thread processing applications data

A

Common turning Parting and grooving

Thread insert

Thread processing applications data

# Turning

## Thread cutting tool

Thread processing applications data

### British Internal and External feed quantity recommend table

Pitch	28	20	19	16	14	12	11	10	9	8	7	6	5
The total amount of feed	<b>0.581</b>	<b>0.813</b>	<b>0.856</b>	<b>1.017</b>	<b>1.162</b>	<b>1.355</b>	<b>1.479</b>	<b>1.626</b>	<b>1.807</b>	<b>2.033</b>	<b>2.324</b>	<b>2.711</b>	<b>3.253</b>
Feed time	<b>5</b>	<b>6</b>	<b>6</b>	<b>8</b>	<b>8</b>	<b>9</b>	<b>9</b>	<b>10</b>	<b>11</b>	<b>12</b>	<b>14</b>	<b>15</b>	<b>16</b>
Tool moving styles	Radial feed(X)and tooth side feed(Z)												
	x/z	x/z	x/z	x/z	x/z	x/z	x/z	x/z	x/z	x/z	x/z	x/z	x/z
1	0.179 /0.070	0.211 /0.089	0.223 /0.094	0.196 /0.097	0.223 /0.111	0.226 /0.122	0.246 /0.133	0.236 /0.139	0.230 /0.147	0.255 /0.158	0.195 /0.167	0.197 /0.189	0.204 /0.219
2	0.134 /0.054	0.172 /0.069	0.181 /0.072	0.186 /0.074	0.213 /0.085	0.234 /0.093	0.255 /0.102	0.226 /0.106	0.282 /0.113	0.304 /0.121	0.322 /0.128	0.361 /0.145	0.421 /0.168
3	0.104 /0.045	0.132 /0.058	0.139 /0.061	0.143 /0.063	0.163 /0.072	0.180 /0.079	0.197 /0.086	0.206 /0.090	0.216 /0.095	0.233 /0.102	0.247 /0.108	0.278 /0.122	0.323 /0.142
4	0.087 /0.040	0.111 /0.051	0.117 /0.054	0.120 /0.055	0.138 /0.063	0.151 /0.069	0.165 /0.076	0.172 /0.079	0.182 /0.084	0.197 /0.090	0.208 /0.095	0.234 /0.108	0.272 /0.125
5	0.077 /0.040	0.098 /0.051	0.103 /0.054	0.106 /0.055	0.121 /0.063	0.133 /0.069	0.145 /0.076	0.152 /0.079	0.161 /0.084	0.173 /0.090	0.183 /0.095	0.207 /0.108	0.240 /0.125
6		0.089 /0.046	0.093 /0.049	0.096 /0.050	0.110 /0.057	0.121 /0.063	0.131 /0.068	0.137 /0.071	0.145 /0.076	0.157 /0.082	0.166 /0.086	0.187 /0.097	0.217 /0.113
7				0.088 /0.046	0.101 /0.052	0.111 /0.058	0.121 /0.063	0.126 /0.066	0.134 /0.070	0.144 /0.075	0.152 /0.079	0.172 /0.089	0.200 /0.104
8				0.082 /0.043	0.093 /0.049	0.103 /0.054	0.113 /0.059	0.117 /0.061	0.124 /0.065	0.134 /0.070	0.142 /0.074	0.160 /0.083	0.186 /0.097
9						0.097 /0.050	0.106 /0.055	0.110 /0.057	0.117 /0.061	0.126 /0.066	0.133 /0.069	0.150 /0.078	0.174 /0.091
10								0.104 /0.054	0.111 /0.058	0.119 /0.062	0.126 /0.066	0.142 /0.074	0.165 /0.086
11									0.105 /0.055	0.113 /0.059	0.120 /0.062	0.135 /0.070	0.157 /0.082
12										0.108 /0.056	0.114 /0.060	0.129 /0.067	0.150 /0.078
13											0.110 /0.055	0.124 /0.064	0.144 /0.075
14												0.119 /0.062	0.138 /0.072
15													0.115 /0.060
16													0.129 /0.067

# Turning

## Thread cutting tool

Thread processing applications data

### NPT Internal and External thread feed quantity recommend table

Pitch	27	18	14	11.5	8
The total amount of feed	<b>0.75</b>	<b>1.129</b>	<b>1.451</b>	<b>1.767</b>	<b>2.54</b>
Feed time	<b>6</b>	<b>8</b>	<b>10</b>	<b>12</b>	<b>14</b>
Tool moving styles	Radial feed(X)and tooth side feed(Z)				
	x/z	x/z	x/z	x/z	x/z
1	0.19/-	0.22/-	0.240/-	0.24/-	0.255/-
2	0.15/0.087	0.181/0.104	0.200/0.115	0.208/0.120	0.250/0.144
3	0.13/0.075	0.152/0.088	0.170/0.098	0.182/0.105	0.245/0.141
4	0.11/0.063	0.141/0.081	0.150/0.086	0.168/0.097	0.230/0.133
5	0.09/0.052	0.131/0.075	0.140/0.081	0.155/0.089	0.210/0.121
6	0.08/0.46	0.121/0.070	0.130/0.075	0.145/0.084	0.195/0.112
7		0.101/0.058	0.120/0.069	0.138/0.079	0.180/0.104
8		0.082/0.047	0.110/0.063	0.124/0.072	0.175/0.101
9			0.100/0.058	0.117/0.067	0.170/0.098
10			0.091/0.052	0.105/0.060	0.155/0.089
11				0.095/0.055	0.140/0.080
12				0.090/0.052	0.125/0.072
13					0.110/0.063
14					0.100/0.058

### BSPT Internal and External thread feed quantity recommend table

Pitch	28	19	14	11
The total amount of feed	<b>0.581</b>	<b>0.856</b>	<b>1.162</b>	<b>1.479</b>
Feed time	<b>5</b>	<b>6</b>	<b>8</b>	<b>10</b>
Tool moving styles	Radial feed(X)and tooth side feed(Z)			
	x/z	x/z	x/z	x/z
1	0.179/-	0.223/-	0.222/-	0.214/-
2	0.134/0.070	0.181/0.094	0.213/0.111	0.242/0.126
3	0.103/0.054	0.139/0.072	0.163/0.085	0.186/0.097
4	0.087/0.045	0.117/0.061	0.138/0.072	0.157/0.082
5	0.078/0.040	0.103/0.054	0.121/0.063	0.138/0.072
6		0.093/0.049	0.110/0.057	0.125/0.065
7			0.101/0.052	0.115/0.060
8			0.094/0.049	0.107/0.056
9				0.100/0.052
10				0.095/0.049

A

Common turning Parting and grooving

Thread insert

Thread processing applications data

A

Common turning Parting and grooving

Thread insert

Thread processing applications data

# Turning

## Thread cutting tool

Thread processing applications data

■ NPTF60°External thread feed quantity recommend table

Pitch	8	11.5	14	18	27
The total amount of feed	2.38	1.63	1.35	1.00	0.64
Feeding times	15	12	10	8	6
Tool moving styles	Radial feed				
1	0.32	0.24	0.23	0.19	0.16
2	0.27	0.23	0.21	0.16	0.14
3	0.23	0.19	0.16	0.14	0.11
4	0.19	0.15	0.14	0.13	0.09
5	0.17	0.13	0.13	0.12	0.08
6	0.16	0.11	0.12	0.11	0.06
7	0.15	0.11	0.11	0.09	
8	0.14	0.11	0.10	0.06	
9	0.13	0.10	0.09		
10	0.12	0.10	0.06		
11	0.12	0.10			
12	0.11	0.06			
13	0.11				
14	0.10				
15	0.06				

■ NPTF60°Internal thread feed quantity recommend table

Pitch	8	11.5	14	18	27
The total amount of feed	2.38	1.63	1.35	1.00	0.64
Feeding times	15	12	10	8	6
Tool moving styles	Radial feed				
1	0.35	0.27	0.25	0.2	0.15
2	0.29	0.22	0.20	0.17	0.13
3	0.26	0.20	0.18	0.15	0.12
4	0.20	0.16	0.14	0.12	0.09
5	0.17	0.13	0.12	0.1	0.08
6	0.15	0.12	0.11	0.09	0.08
7	0.14	0.10	0.10	0.09	
8	0.12	0.10	0.09	0.08	
9	0.12	0.09	0.08		
10	0.11	0.08	0.08		
11	0.10	0.08			
12	0.10	0.08			
13	0.09				
14	0.09				
15	0.09				

■ 30°Round external thread feed quantity recommend table

Pitch	6	8	10
The total amount of feed	2.12	1.59	1.27
Feeding times	12	10	8
Tool moving styles	Radial feed		
1	0.26	0.23	0.23
2	0.225	0.21	0.21
3	0.24	0.20	0.20
4	0.22	0.19	0.19
5	0.21	0.18	0.16
6	0.19	0.16	0.12
7	0.17	0.14	0.10
8	0.16	0.12	0.06
9	0.14	0.10	
10	0.12	0.06	
11	0.10		
12	0.06		

■ 30°Round external thread feed quantity recommend table

Pitch	6	8	10
The total amount of feed	2.12	1.59	1.27
Feeding times	12	10	8
Tool moving styles	Radial feed		
1	0.35	0.29	0.26
2	0.29	0.24	0.22
3	0.26	0.22	0.20
4	0.20	0.17	0.15
5	0.17	0.14	0.13
6	0.15	0.13	0.11
7	0.14	0.11	0.10
8	0.13	0.10	0.09
9	0.12	0.10	
10	0.11	0.09	
11	0.10		
12	0.10		

■ MJExternal thread feed quantity recommend table

Pitch	1.5	2.0
The total amount of feed	0.87	1.16
Feeding times	6	8
Tool moving styles	Radial feed	
1	0.22	0.25
2	0.19	0.21
3	0.16	0.18
4	0.13	0.15
5	0.11	0.12
6	0.06	0.10
7		0.09
8		0.06

■ UNJ External thread feed quantity recommend table

Pitch	8	10	12	14	16	18	20	24	28	32
The total amount of feed	1.83	1.47	1.22	1.05	0.92	0.81	0.73	0.61	0.52	0.46
Feeding times	11	9	7	7	6	6	6	5	5	4
Tool moving styles	Radial feed									
1	0.31	0.30	0.28	0.26	0.26	0.23	0.19	0.17	0.16	0.16
2	0.30	0.29	0.27	0.23	0.21	0.18	0.16	0.14	0.12	0.14
3	0.23	0.21	0.20	0.17	0.14	0.14	0.13	0.14	0.09	0.10
4	0.18	0.15	0.17	0.12	0.12	0.10	0.10	0.10	0.09	0.06
5	0.15	0.13	0.13	0.11	0.10	0.010	0.09	0.06	0.06	
6	0.14	0.12	0.11	0.10	0.09	0.06	0.06			
7	0.13	0.11	0.06	0.06						
8	0.12	0.10								
9	0.11	0.06								
10	0.10									
11	0.06									

■ Tr External thread feed quantity recommend table

Pitch	1.5	2	3
The total amount of feed	0.90	1.25	1.75
Feeding times	6	7	9
Tool moving styles	Radial feed		
1	0.23	0.29	0.32
2	0.21	0.26	0.31
3	0.16	0.21	0.24
4	0.13	0.17	0.19
5	0.11	0.14	0.18
6	0.06	0.12	0.17
7		0.06	0.15
8			0.13
9			0.06

■ TrInternal thread NPTF60 feed quantity recommend table

Pitch	1.5	2	3
The total amount of feed	0.90	1.25	1.75
Feeding times	6	7	9
Tool moving styles	Radial feed		
1	0.22	0.28	0.34
2	0.18	0.23	0.28
3	0.17	0.21	0.26
4	0.13	0.16	0.20
5	0.11	0.14	0.17
6	0.10	0.12	0.15
7		0.11	0.13
8			0.12
9			0.10

# Turning

## Thread cutting tool

Thread processing applications data

# Turning

■ MJExternal thread feed quantity recommend table

Pitch	1.5	2.0
The total amount of feed	0.87	1.16
Feeding times	6	8
Tool moving styles	Radial feed	
1	0.22	0.25
2	0.19	0.21
3	0.16	0.18
4	0.13	0.15
5	0.11	0.12
6	0.06	0.10
7		0.09
8		0.06

■ UNJ External thread feed quantity recommend table

Pitch	8	10	12	14	16	18	20	24	28	32
The total amount of feed	1.83	1.47	1.22	1.05	0.92	0.81	0.73	0.61	0.52	0.46
Feeding times	11	9	7	7	6	6	6	5	5	4
Tool moving styles	Radial feed									
1	0.31	0.30	0.28	0.26	0.26	0.23	0.19	0.17	0.16	0.16
2	0.30	0.29	0.27	0.23	0.21	0.18	0.16	0.14	0.12	0.14
3	0.23	0.21	0.20	0.17	0.14	0.14	0.13	0.14	0.09	0.10
4	0.18	0.15	0.17	0.12	0.12	0.10	0.10	0.10	0.09	0.06
5	0.15	0.13	0.13	0.11	0.10	0.010	0.09	0.06	0.06	
6	0.14	0.12	0.11	0.10	0.09	0.06	0.06			
7	0.13	0.11	0.06	0.06						
8	0.12	0.10								
9	0.11	0.06								
10	0.10									
11	0.06									

■ Tr External thread feed quantity recommend table

Pitch	1.5	2	3
The total amount of feed	0.90	1.25	1.75
Feeding times	6	7	9
Tool moving styles	Radial feed		
1	0.23	0.29	0.32
2	0.21	0.26	0.31
3	0.16	0.21	0.24
4	0.13	0.17	0.19
5	0.11	0.14	0.18
6	0.06	0.12	0.17
7		0.06	0.15
8			0.13
9			0.06

■ TrInternal thread NPTF60 feed quantity recommend table

Pitch	1.5	2	3
The total amount of feed	0.90	1.25	1.75
Feeding times	6	7	9
Tool moving styles	Radial feed		
1	0.22	0.28	0.34
2	0.18	0.23	0.28
3	0.17	0.21	0.26
4	0.13	0.16	0.20
5	0.11	0.14	0.17
6	0.10	0.12	0.15
7		0.11	0.13
8			0.12
9			0.10

A

Common turning Parting and grooving

Thread insert

Thread processing applications data

A

Common turning Parting and grooving

Thread insert

Thread processing applications data

# Turning

## Thread cutting tool

Thread processing applications data

■ ACME Internal External thread feed quantity recommend table

Pitch	8	10	12	14	16
The total amount of feed	1.86	1.55	1.21	1.05	0.94
Feeding times	12	10	8	7	6
Tool moving styles	Radial feed				
1	0.31	0.28	0.25	0.23	0.23
2	0.26	0.23	0.21	0.20	0.19
3	0.23	0.21	0.18	0.18	0.17
4	0.18	0.16	0.15	0.14	0.14
5	0.15	0.15	0.12	0.11	0.11
6	0.14	0.13	0.11	0.10	0.10
7	0.12	0.11	0.10	0.09	
8	0.11	0.10	0.09		
9	0.10	0.09			
10	0.09	0.09			
11	0.09				
12	0.08				

■ STUB-ACME Internal External thread feed quantity recommend table

Pitch	8	10	12	14	16
The total amount of feed	1.28	1.08	0.81	0.73	0.66
Feeding times	9	8	7	6	5
Tool moving styles	Radial feed				
1	0.22	0.20	0.17	0.17	0.17
2	0.20	0.18	0.14	0.14	0.15
3	0.18	0.15	0.12	0.12	0.14
4	0.15	0.13	0.1	0.11	0.11
5	0.12	0.12	0.1	0.1	0.09
6	0.11	0.11	0.09	0.09	
7	0.11	0.10	0.09		
8	0.10	0.09			
9	0.09				

■ API 60° External thread feed quantity recommend table

Pitch	4(382)	4(383)	5(403)	4(502)	4(503)
The total amount of feed	3.12	3.11	3.00	3.78	3.77
Feeding times	12	12	12	15	15
Tool moving styles	Radial feed				
1	0.51	0.50	0.47	0.51	0.51
2	0.47	0.47	0.44	0.48	0.48
3	0.42	0.42	0.40	0.44	0.44
4	0.35	0.35	0.35	0.39	0.39
5	0.31	0.31	0.30	0.34	0.34
6	0.26	0.26	0.25	0.30	0.30
7	0.22	0.22	0.21	0.26	0.26
8	0.18	0.18	0.17	0.22	0.22
9	0.13	0.13	0.14	0.19	0.19
10	0.11	0.11	0.11	0.16	0.16
11	0.10	0.10	0.10	0.13	0.13
12	0.06	0.06	0.06	0.11	0.10
13				0.10	0.10
14				0.09	0.09
15				0.06	0.06

■ API 60° Internal thread feed quantity recommend table

Pitch	4(382)	4(383)	5(403)	4(502)	4(503)
The total amount of feed	3.12	3.11	3.00	3.78	3.77
Feeding times	12	12	12	15	15
Tool moving styles	Radial feed				
1	0.52	0.52	0.51	0.55	0.54
2	0.43	0.43	0.42	0.46	0.46
3	0.39	0.39	0.38	0.42	0.42
4	0.30	0.30	0.29	0.32	0.32
5	0.25	0.25	0.24	0.27	0.27
6	0.22	0.22	0.21	0.24	0.24
7	0.20	0.20	0.19	0.22	0.22
8	0.18	0.18	0.17	0.20	0.20
9	0.17	0.17	0.16	0.18	0.18
10	0.16	0.16	0.15	0.17	0.17
11	0.15	0.15	0.14	0.16	0.16
12	0.15	0.14	0.14	0.16	0.16
13				0.15	0.15
14				0.14	0.14
15				0.14	0.14

■ API Round external thread feed quantity recommend table

Pitch	8	10
The total amount of feed	1.81	1.41
Feeding times	12	10
Tool moving styles	Radial feed	
1	0.25	0.25
2	0.24	0.23
3	0.19	0.16
4	0.16	0.14
5	0.14	0.12
6	0.14	0.12
7	0.13	0.12
8	0.13	0.11
9	0.13	0.1
10	0.13	0.06
11	0.11	
12	0.06	

■ API Round external thread feed quantity recommend table

Pitch	8	10
The total amount of feed	1.81	1.41
Feeding times	12	10
Tool moving styles	Radial feed	
1	0.30	0.26
2	0.25	0.21
3	0.22	0.19
4	0.17	0.15
5	0.15	0.13
6	0.13	0.11
7	0.12	0.10
8	0.11	0.09
9	0.10	0.09
10	0.09	0.08
11	0.09	
12	0.08	

■ API Buttress thread external thread feed quantity recommend table

Pitch	5
The total amount of feed	1.55
Feeding times	11
Tool moving styles	Radial feed
1	0.25
2	0.23
3	0.17
4	0.15
5	0.13
6	0.12
7	0.12
8	0.11
9	0.11
10	0.1
11	0.06

■ API Buttress thread external thread feed quantity recommend table

Pitch	5
The total amount of feed	1.55
Feeding times	11
Tool moving styles	Radial feed
1	0.27
2	0.22
3	0.20
4	0.16
5	0.13
6	0.12
7	0.10
8	0.10
9	0.09
10	0.08
11	0.08

A

Common turning Parting and grooving

Thread insert

Thread processing applications data

A

Common turning Parting and grooving

Thread insert

Thread processing applications data

### Turning condition recommended list

ISO	Material		Unit cutting force Kc0.4 N/mm <sup>2</sup>	Hardness HB	Grade		
					JT1025	JK301	
					Cutting speed(m/min)		
P	Carbon steel	C=0.15%	1900	125	150-175	110-140	
		C=0.35%	2100	150	140-155	100-120	
		C=0.60%	2250	200	130-145	90-110	
	Alloy steel	Annealed	2100	180	110-130	70-100	
		Hardened	2600	275	80-100	60-80	
		Hardened	2700	300	70-90	50-70	
	High alloy steel	Annealed	2600	200	90-115	70-90	
		Hardened	3900	325	70-90	50-70	
	Cast steel	Un alloy	2000	180	180-210	140-170	
		Low alloy	2500	200	90-115	60-80	
		High alloy	2700	225	90-115	60-80	
		Martensitic steel	3600	250	40-50	30-40	
M	Stainless steel	Austenitic	2450	180	110-130	70-110	
		Martensitic/Ferritic	2300	200	130-170	100-140	
K	Malleable cast iron	Ferritic	1100	130	110-140	80-120	
		Pearlitic	1100	230	85-105	70-90	
	Grey cast iron	Low tensile strength	1100	180	110-140	80-110	
High tensile strength		1500	260	90-115	70-100		
Nodular cast iron	Ferritic Pearlitic	1100	160	110-130	80-120		
		1800	250	80-100	60-80		
N	Alumium alloy	Non aging	500	60	1300-1450	1100-1200	
		Aged	800	100	450-500	350-400	
Cast alumium alloy	Non aging Aged	750	75	430-470	400-420		
		900	90	250-290	200-240		
S	Heat-resistant alloy	Fe based	Annealed	3000	200	35-50	25-35
			Aged	3050	280	25-35	20-30
		Nickel or Cobalt based	Annealed	3500	250	15-25	10-15
			Aged Cast	4150	350	10-20	10-15
4150	320	10-15	10-15				
H	Harded steel	Harded steel	4500	HRC55	40-50	30-40	

- Note:
- The list shows the range number would choose high number in cutting,when use new cutting speed,should check the edge condition.
  - Would use high cutting speed in stainless thread cutting,avoid built-up.
  - Would reduce cutting parameter in small pitch threading and using small nose radius tool.
  - Would use big nose radius roughing to improve small nose radius tool life in using small nose radius tool threading.

### Thread tools feed method

#### Radial in-feed

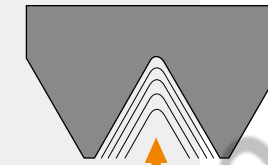

- Simple to use,high generality.
- The V type chipping caused by machining steel will produce high bend stress on cutting edge.
- It ask for small cutting depth,sharp edge and good toughness when processing.
- High cutting heat,it's hard to control the V type chipping.
- Due to the left and the right of the chipping contact length is long,easy to produce vibration,and increase the nose load.

#### Flank in-feed



- Small bending stress of cutting edge,stable condition,better shape chipping,large cutting depth.
- There is enough space for chipping discharge when flank in-feed.
- Severe wear on right flank.

#### Modified flank in-feed

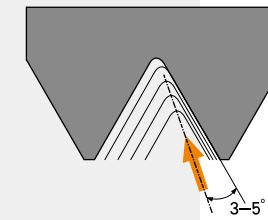

- Right cutting edge also engage on cutting depth to a certain extent, it can reduce the abrasion on right size of clearance face.
- Small bending stress of cutting edge,stable condition,better shape chipping,large cutting depth
- Good cutting processing performance.

#### Alternate flank in-feed

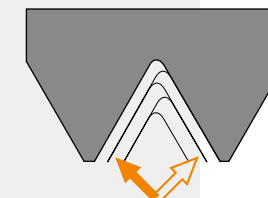

- Alternate use cutting edge,even wearing of left and right side back tool face,can lengthen tool life.
- Chipping discharge from left and right direction,good chip flow.
- Suitable for big pitch thread cutting.

**!** Try to use Flank in-feed or Alternate flank in-feed under the condition of machine tools and programming system allows,and can effectively eliminate vibration,enough space for chipping discharge between teeth,small stress of cutting edge,stable condition,chipping controlled when processing thread.



# Turning

## Thread cutting tool

Thread processing applications data

A

Common turning Parting and grooving

Thread insert

Thread processing applications data

### Thread processing common problems and solutions

Trouble	Reason	Solution
Severe abrasion of clearance face	High cutting speed	Lower cutting speed
	Small feed, cause abrasion	Reduce feed times and edge friction times
	The insert is located in the center line of the above angle of inclination	Choose proper shim to obtain correct angle of inclination
Uneven cutting edge wear	Angle of inclination and helix angle are inconsistent	Change infeed method
	Wrong infeed method	Change infeed method
Breakage	Low cutting speed	Improve the cutting speed
	High cutting force	Increase infeed times, reduce Max. cutting feed
	Turning in the unstable clamping condition	Check stability. Reduce the tool overhanging volume verify clamping of workpiece and tool.
	Chipping are twisting	Increase the cooling fluid pressure, blow chip
Plastic deformation	High cutting speed, high temperature of cutting zone	Reduce cutting speed Increase feed times, reduce max feed depth
	Insufficient cutting fluid	Increase the cooling fluid supply
Poor surface quality	Low cutting speed The insert is located in the center line of the above Chipping uncontrolled.	Increase cutting speed Adjust the center height Change the feed type of tool, proper handle chipping
Incorrect thread profile	Incorrect center height.	Adjust the center height.
	Incorrect pitch.	Check the machine tool
Shallow thread profile	Wrong set of cutting depth	Change cutting depth
Surface damage	Chipping involved or contact.	Use tooth flank cross cutting, control chipping discharge direction.
Built-up edge	Low temperature of cutting edge When machining stainless steel and low carbon steel.	Increase the cutting speed cutting fluid pressure and concentration, choose better toughness tool
Fracture of surface	High cutting force	Reduce cutting depth
Vibration	Incorrect clamping of workpiece or tool	check the clamping condition Min overhang of tool.
	Incorrect of cutting parameter	Increase cutting speed or largely reduce cutting speed
	Incorrect of tool clamping.	Adjust the center height

The functions of each part of turning tools

1. The names of each part of turning tools

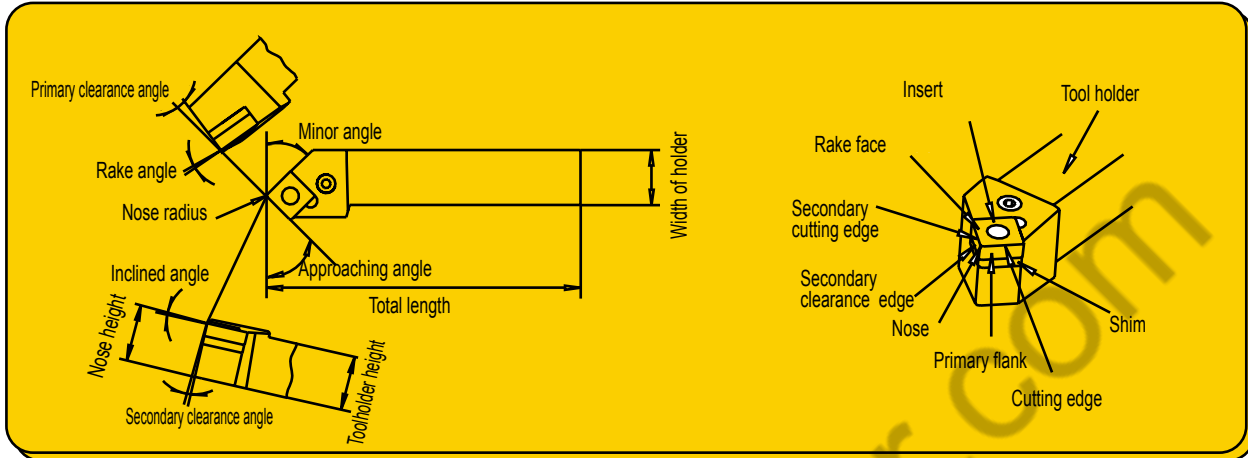

2. Effects of rake angle

Large rake angle makes cutting edge sharper, reduces resistant forces of chip flow, diminishes friction and prevent deformation, leading to smaller cutting forces and cutting power, lower cutting temperature, less abrasion and higher surface quality. However, too large rake angle would reduce the rigidity and strength of tool. Heat can't be diffused easily. Serious breakage and abrasion on tool would occur, reducing tool life. Please choose rake angle according to machining conditions.

Value selection	Situations
Small rake angle	<ul style="list-style-type: none"> <li>● When machining brittle and hard materials</li> <li>● When roughing and intermittent cutting</li> </ul>
Big rake angle	<ul style="list-style-type: none"> <li>● When machining plastic or soft materials</li> <li>● When finishing</li> </ul>

3. Effects of clearance angle

The main function of clearance angle is to reduce the friction between the clearance face of tool and surface of workpiece. When the rake angle is fixed, larger clearance angle can increase the sharpness of cutting edge, reduce cutting force and friction, and then achieve higher surface quality. However, if clearance angle is too large, the strength of cutting edge would decrease. Also, heat can't be diffused easily and serious abrasion would occur, reducing tool life.

The principle of choosing clearance angle: Choose small clearance angle if friction is not serious.

Value selection	Situations
Small clearance angle	<ul style="list-style-type: none"> <li>● In order to increase nose strength when roughing</li> <li>● When machining brittle and hard materials</li> </ul>
Big clearance angle	<ul style="list-style-type: none"> <li>● In order to reduce friction when finishing</li> <li>● When machining materials easy to be hardened</li> </ul>

4. Effect of inclined angle

Positive or negative inclined angle determines the direction of chip flow, and also affects the strength and impact resistance of insert nose.

- ◆ As diagram(1) shows, when the inclined angle is negative, namely nose is in the lowest point as apposed to the bottom of tool, chips flow to the machined surface of workpiece.

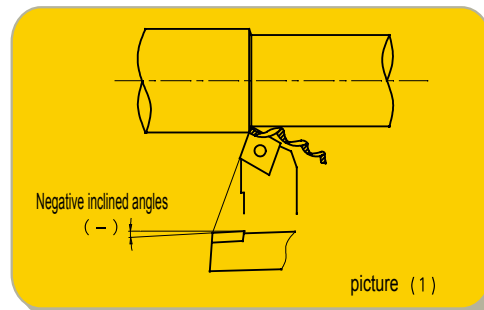

- ◆ As diagram(2) shows, when inclined angle is positive, namely the nose is in the highest point as apposed to the bottom of the tool, chips flow to the areas of workpiece surface that haven't been machined.
- ◆ The change of inclined angle also affects insert nose strength and impact resistance. When the inclined angle is negative, the nose is in the lowest point of cutting edge. When the cutting edge enters the workpiece, the contacting point is on the cutting edge or rake face, protecting the nose from impact and increase the strength of the nose. Normally, negative inclined angle should be chosen for tools with big rake angle. This can not only increase nose strength, but also prevent the impact of entry.

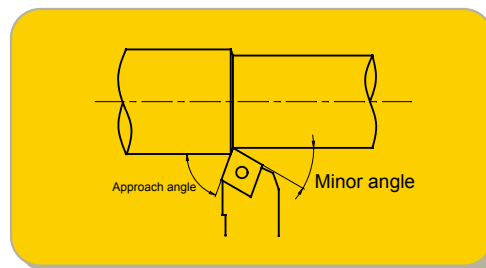
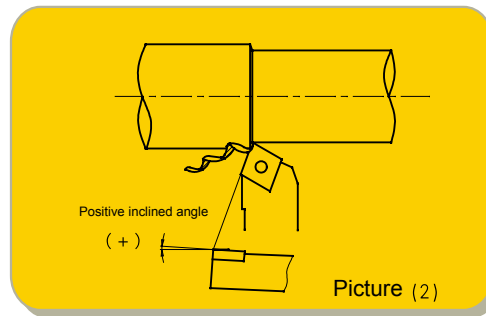

Value selection	Situaiions
Small approach angle	● For those materials with high intensity,high hardness and hardened layer on the surface
Big approach angle	● When rigidity of the machine is not enough

#### 5、Effect of approach angle

Reduced approaching angle increase the strength of tools and enable heat to diffuse easily, improving surface quality. This is because when the approach angle is small, cutting edge width is large, and then the unit width of cutting edge bears less cutting force. Meanwhile, tool life can be improved.

Normally, select 90 approach angle for turning of slender and step shaft; select 45 approach angle for external turning, end surface machining and chamfering. When approach angle is larger, radia force is reduced, cutting is stable, cutting thickness is increased, and chip breaking is excellent.

#### 6、Effect of minor angle

Minor angle is the main angle that can affect surface quality, and it can also affect tool strength. If the approach angle is too small, the friction between the secondary flank and machined surface of workpiece will increase, causing vibration.

The principle of selecting minor angle: Select small minor angle when roughing or when the friction is unaffected and there is no vibration. Select large minor angle when finishing.

#### 7、Nose radius

Nose radius significantly affects nose strength and surface quality. Large nose radius means higher cutting edge strength, and the abrasion on the rake face and clearance face can be reduced to some extent. However, if the nose radius is too large, radias force will increase, and vibration ia easy to occur, affecting machining precision and surface quality.

Value selection	Situaiions
Small nose radius	<ul style="list-style-type: none"> <li>● Finishing at small cutting depth</li> <li>● Machining parts such as slender shaft</li> <li>● When the rigidity of the machine is not enough</li> </ul>
Large nose radius	<ul style="list-style-type: none"> <li>● When roughing</li> <li>● When machining hard materials,intermittent cutting</li> <li>● When the rigidity of the machine is not enough</li> </ul>

### Calculate method of turning parameter

#### 1、Calculating the cutting speed

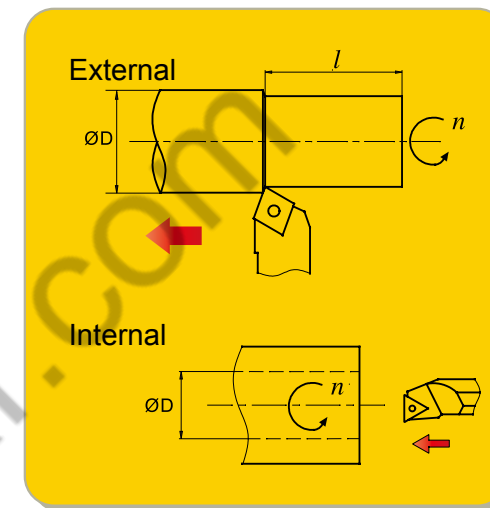

$$V_c = \frac{\pi \times D \times n}{1000} \text{ (m/min)}$$

Vc: Cutting speed

n: Spindle speed

D: Workpiece diameter

Ex: If spindle speed is 280 rev/min,turning the diameter of 150mm,the cutting speed is:

$$V_c = \frac{\pi \times D \times n}{1000} \text{ (m/min)} = 132 \text{ (m/min)}$$

#### 2、Calculating the cutting feed

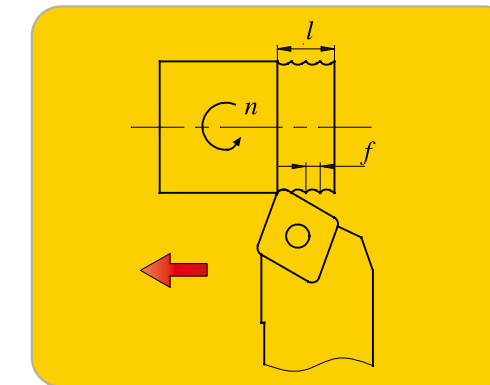

$$f = \frac{l}{n} \text{ (mm/rev)}$$

f: Feed rate per revolution

l: Cutting length per minute

n: Spindle speed

Ex: If spindle speed is 500rev/min,cutting length per minvte is 100mm/min,the feed rate per revolution is:

$$f = \frac{l}{n} = \frac{100}{500} = 0.2 \text{ (mm/rev)}$$

### 3、Calculating the cutting time of external and internal

$$T = \frac{l}{f \times n} \text{ (min)}$$

T:Cutting time

l:Length of cutting zone

f:Feed rate

n:Spindle speed

Ex:If spindle speed is 250rev/min,feed rate is 0.2mm/rev, the cutting length is 150mm, the time requires:

$$T = \frac{l}{f \times n} = \frac{150}{0.2 \times 250} = 3 \text{ (min)}$$

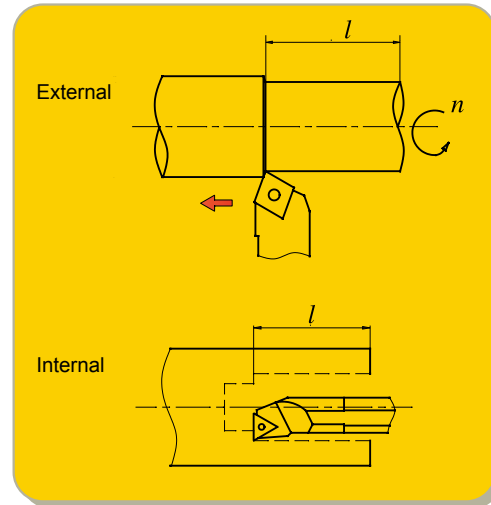

### 4、Calculating the time of face turning(constant line speed)

$$T = \frac{\pi \times (a^2 - b^2)}{4000 \times V_c \times f} \text{ (min)}$$

T:Cutting time

V<sub>c</sub>:Cutting speed

f:Feed rate

If it's no inner hole of turning face,b=0,the formula is still valid.

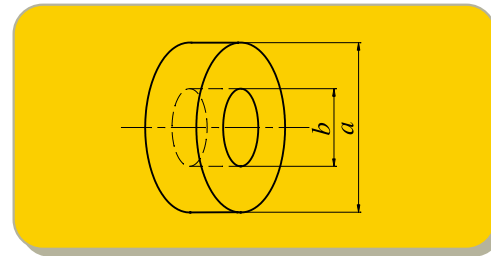

### 5、Calculating the theoretical value of surface roughness

$$R = \frac{f^2}{8r_c} \times 1000 \text{ (}\mu\text{m)}$$

R:The theoretical value of surface roughness

f:Feed rate

r<sub>c</sub>:Nose radius

Ex: If feed rate is 0.2mm/rev,nose radius is 0.4mm,the theoretical value of surface roughness is:

$$R = \frac{f^2}{8r_c} \times 1000 = \frac{0.2^2}{8 \times 0.4} \times 1000 = 12.5 \text{ (}\mu\text{m)}$$

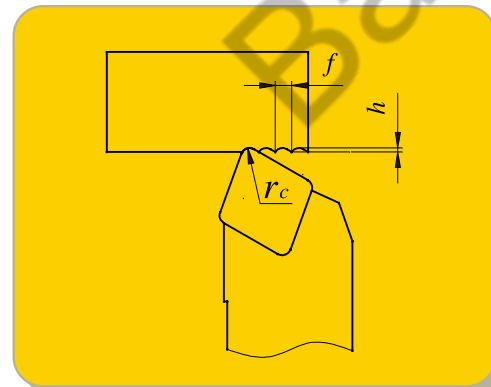

### Effect of three main turning parameters on machining

#### ★ Effect of three main parameters

Normally, short machining time, long tool life and high machining precision are expected in machining, so the material quality, hardness, and the shape of the workpiece, and properties of machine should be fully considered, and then we can select suitable tools adopt high-efficiency cutting parameters, namely three parameters.

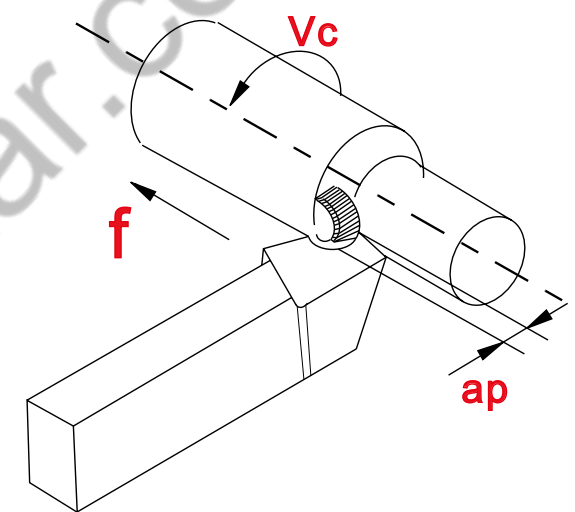

(1) Normally tool life would be reduced to half when the cutting speed is increased by 20%. Tool life would be 20% of the original life if the cutting speed is raised by 50%.

(2) Low speed (20-40m/min) cutting would easily cause vibration and shorten tool life.

#### ★ Feed rate (fn)

Feed rate is defined as the moving distance of tool after workpiece rotates for one circle, measured by mm/rotation.

#### ★ Effect of feed rate

Feed rate is a key factor that determines surface quality. Meanwhile it also affect the range of chip formig and the thickness of chips during machining.

In terms of the effect on tool life, small feed rate leads to serious abrasion on clearance face, greatly reducing tool life.

#### ★ Cutting depth (ap)

Cutting depth is defined as the difference between machined surface and unmachined surface, measured by mm. It is half the difference value between the original diameter and machined diameter.

#### ★ Effect of cutting depth

Cutting depth should be determined by the machining allowance and shape of workpiece, power and rigidity of machine, and tool rigidity.

The change of cutting depth has little effect on tool life. If the cutting depth is too low, the cutting nose only scrapes the hardened layer on the workpiece surface, reducing tool life. When there is hardened oxide layer on workpiece surface, higher cutting depth should be adopted within the possible range of machine's power to avoid cutting nose just cutting the hardened layer of workpiece.

#### ★ Cutting speed(Vc)

When the workpiece is rotating on the machine, the number of its rotation per minute is defined as Rotating speed of main axle (n). Because of its rotation, the cutting speed measured on the contacting point of diameter is defined as linear speed, m/min. Normally, linear speed is considered to measure the effect of cutting speed on machining.

#### ★ Effect of cutting speed

Cutting speed has significant effect on tool life. When the cutting speed is increased, cutting temperature will increase and tool life will be shortened. Cutting speed varies according to the different types and hardness of workpiece. The below conclusions are reached after many cutting experiments:

Turning inserts groove comparison table (negative insert)

ISO type	Processing category	JXTC 江钨刀具	SANDVIK 山特维克	KORLOY 克洛伊	TaeguTec 特固克	WALTER 瓦尔特	SECO 山高	MISTUBISHI 三菱	SUMITOMO 住友	KENNAMETAL 肯纳	DIJET 黛杰	HITACHI 日立	TUNGALOY 泰珂洛	KYOCERA 京瓷	VALANTTE 万耐特
P	Super-finishing		QF	HU		NF3	FF1	PK** FH, FY	FA, FL	UF, FF		FE	01**, TF, ZF	DP**, GP, VF XP, XP-T	F1
	Finishing	GF	PF MF	HF	FG	NS6	MF2	C, SA, SH	SU, LU, SX	LF, FN	PF, UR UA, UT	BE, CE	NS, 27 TS, AS	HQ, CQ	F2(2B), F5(5C)
	Finishing (mild steel)	GF		HF		NF		SY	LUW	FW			17	XQ, XS	
	Finishing(wiper)		WP WF	HW			W-MF2	SW					AFW, ASW	WP, WQ	
Semi-finishing		WM				NM	W-M3	GUW	MW						
Roughing	GR(Double side)	PR			MT, MG	NM9	MR7	GH	MU, MX	RN	UD, GG	AR, RE	TH	GT, HT	
Heavy load roughing	GR(One side)ZR	QR PR HR		HR HH	RT, RH	NR6	R4, R6 R7, PR9	HZ, HX HV	MP, HG HP	MR, RM RH	UC	HX HE	57, 65, TU	HX	R3, R4, R6(9A) R7(9B), R9(9C)

\*\* Peripheral grinding type

Turning inserts groove comparison table (negative insert)

ISO type	Processing category	JXTC 江钨刀具	SANDVIK 山特维克	KORLOY 克洛伊	TaeguTec 特固克	WALTER 瓦尔特	SECO 山高	MISTUBISHI 三菱	SUMITOMO 住友	KENNAMETAL 肯纳	DIJET 黛杰	HITACHI 日立	TUNGALOY 泰珂洛	KYOCERA 京瓷	VALANTTE 万耐特
M	Finishing	BF	MF	HA	FG, SF	NF4		FS	SU	K, FP		SE	SS	GU	F1, F2(2B), F5(5C)
	Semi-finishing	BM	MM	HS	ML, MP	NM4		MS, ES	EX, UP	P, MP	SF, SG	DE	SA, SM, S	SU, HU, ST	F3, F4(8A), M2(2C), M3 M4, M5(5B), M6, M7, 55, M8
	Roughing	BR	MR	GS, HM	MT, RH	NR4	M5, MR7 56, R6	GH, HZ	MP	RP					R3, R4, R6(9A) R7(9B), R9(9C)
	Finishing	GM	KF	No chipbreaker	FG	MA		complete cycle	UZ	FN		Y	CM	complete cycle, C	F2(2B)
Semi-finishing	GM	KM	complete cycle, HM	MC, MT, MG	MA, NM5		complete cycle	UX	complete cycle, UN		V	33, complete cycle	ZS, GC	M5(5B), M6, M8	
Roughing	No chipbreaker	KR	GR, HR, GH	RT, RH	MA		No chipbreaker	No chipbreaker						No chipbreaker	R3, R4, R7(9B)
Finishing				SF	NF4	MF1**	FJ**		FS**, K**					F5(5C), M2(2C)	
Semi-finishing		NGP**, 23			NM4	M1	MJ**	SU**	NGP**			SA		M4, M5(5B), M7, 55	
Roughing		SR			NR4		GJ		MS						

\*\* Peripheral grinding type



# Turning

## General technical information of turning

### Turning inserts groove comparison table

Turning inserts groove comparison table (negative insert)

ISO type	Processing category	JXTC 江钨刀具	SANDVIK 山特维克	KORLOY 克洛伊	TaeguTec 特固克	WALTER 瓦尔特	SECO 山高	MISTUBISHI 三菱	SUMITOMO 住友	KENAMETAL 肯纳	DIJET 黛杰	HITACHI 日立	TUNGALOY 泰珂洛	KYOCERA 京瓷	VALANTTE 万耐特
P	Finishing	SF, HF	UF, PF	HFP	FA, FG	PF4	FF1 F1	FV, SV	FP, LU SU, SK	11, UF LF		JQ	01※, PF FS	GP, XP VF	PF4 JQ, JZ
	Finishing (mild steel)		WK※, W WP			PF	W-F1	SW	LUW	FW					
	Semi-finishing	HM	UM PM	HMP C25	MT, CMX	PS5 PM5	F2	IMV, complete cycle	MU	MF	FT	JE	PM 23, 24	HQ, XQ GK	PM2 PM4
	Semi-finishing (wiper)		WM			PM		MW		MW					
M	Finishing	BF	MF	HFP	FA, FG	PF4		SV					SS※		1A, 2A
	Semi-finishing	BM	MM	HMP C25	MT CMX	PS5 PM5		complete cycle MV							PM2 PM4
K	Semi-finishing	HM, HRNo chipbreaker	KF KM KR	HMP C25	MT CMX	MW PS5 PM5		No chipbreaker	No chipbreaker※		FT		No chipbreaker	No chipbreaker※	PM2 PM4
	Finishing/ Semi-finishing					PF4 PS5 PM5		FJ※	SC※	LF※ HP※					PM2, 1A 2A
N	Common turning	AH, AC	AL	TAAK MA	FL	PM2			AG	HP	ALU ACB		PP	A3	1L, 1A 2A

※ Peripheral grinding type

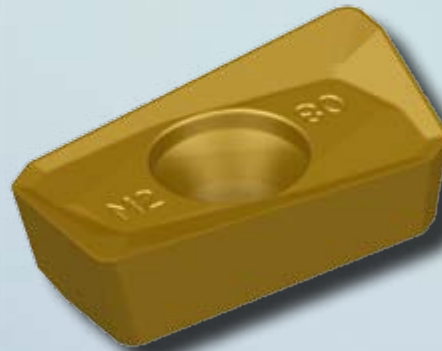
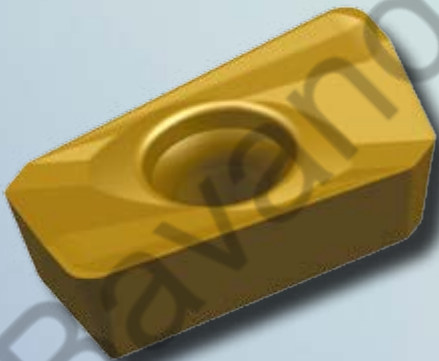
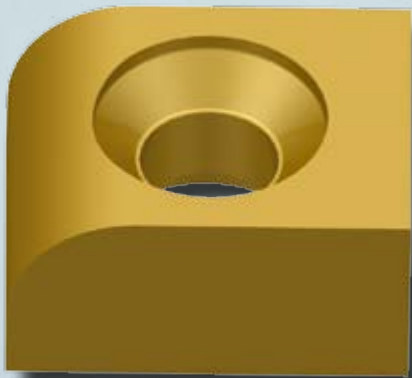
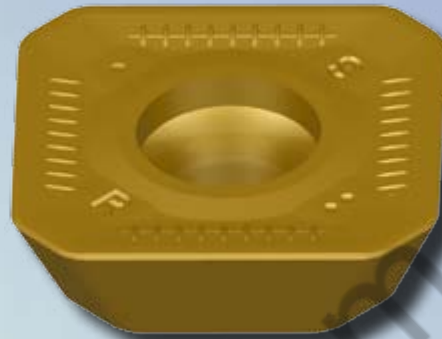
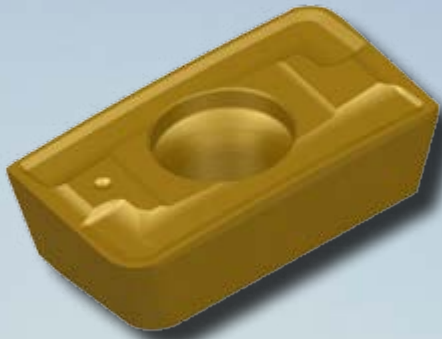

BavendAbzar.com

# Milling

## Indexable milling cutter

Indexable milling insert grade overview	B8
Indexable milling insert grade classification	B9-B10
Indexable milling insert naming rules	B96-B97
Indexable milling insert specification	B98-B118
Indexable milling technical information	B119-B124

### Indexable milling inserts grade overview

Material	ISO Code	Coated cemented carbide		Cemented carbide
		CVD	PVD	
<b>P</b> Steel	P01		JT1015	
	P10	JT4330	JT1025	JT1215
	P20	JT4340	JT1035	JT1225
	P30	JT4350	JT1235	JPP302
	P40		JPP402	JPP402
<b>M</b> Stainless steel	M01		JT1215	
	M10	JT4330	JT1225	
	M20	JT4340	JT1235	
	M30	JT4350		
	M40			
<b>K</b> Cast iron	K01			
	K10	JT1035	JT1015	JK101
	K20			JK202
	K30	JT1045	JT1025	
	K40			
<b>N</b> Non-Ferrous metal	N01			
	N10			JK002
	N20			
	N30			
<b>S</b> Heat resistant high quality alloy steel	S01			
	S10		JT1225	
	S20			
	S30			
<b>H</b> Harden material	H01			
	H10			
	H20			
	H30			

Indexable milling inserts grade classification

Indexable milling inserts grade classification

**CVD Coated Cemented Carbide**

**PVD Coated Cemented Carbide**

Material	Coating structure	Structure picture	ISO Application	Application fields
JT4330	High toughness gradient alloy substrate and the combination of TiCN, ultrafine nano Al <sub>2</sub> O <sub>3</sub> coating.		<b>M10~30</b>	Suitable for M material of roughing milling
JT4340	Toughness and hardness of matrix and the combination of TiCN, ultrafine nano Al <sub>2</sub> O <sub>3</sub> coating.		<b>P25~40</b> <b>M20~35</b>	Suitable for P&M material of roughing milling
JT4350	Good toughness & wear-resistant substrates, perfect combinations with MT-TiCN, superfine Al <sub>2</sub> O <sub>3</sub> , common coating cemented carbide grades.			Suitable for medium and low speed milling of steel, cast iron, hardened steel.

Material	Coating structure	ISO Application	Application fields
JT1015	Fine particles alloy matrix + nano coating	<b>K05~K20</b>	Suitable for K material of semi-finishing milling and finishing milling
JT1025	Excellent resistance to deformation ability substrate material + nano coating	<b>P10~30</b>	Strong commonality of PVD grade, widely applicable to P, M, S materials semi-finishing milling.
		<b>M10~30</b>	
		<b>S05~20</b>	
JT1035	High strength cemented carbide substrates + nano coating	<b>M10~30</b>	Suitable for M material of semi-finishing milling and roughing milling
JT1215	3-5µm TiAlN+TiAlSiN PVD Coated, high wear resistance, high oxidation resistance, combined with fine particle's substrates with excellent performance		suitable for light, medium load milling
JT1225			
JT1235	3-5µm TiAlN+TiAlSiN PVD Coated, high wear resistance, high oxidation resistance, combined with hard alloy with excellent toughness cemented carbide substrates		suitable for M materials with high hardness and medium load milling and drilling, high temperature alloy in semi-finishing, rough turning, cutting and grooving.

# Milling

## Indexable milling cutter

### Indexable milling inserts grade classification

# Cemented carbide

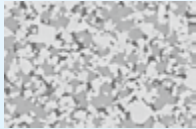
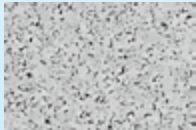
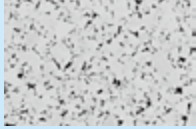
Material	Metallographical structure	ISO Application	Application fields
JP302 JP402		P25~40 M25~40	Suitable for P & M material of roughing milling
JK002		K05~20	Suitable for K material of finishing milling
JK101		N05~25	Suitable for N material of semi-finishing milling and finishing milling
JK202		K15~35 N15~30	Suitable for K material of semi-finishing milling and roughing milling, N material of roughing milling.

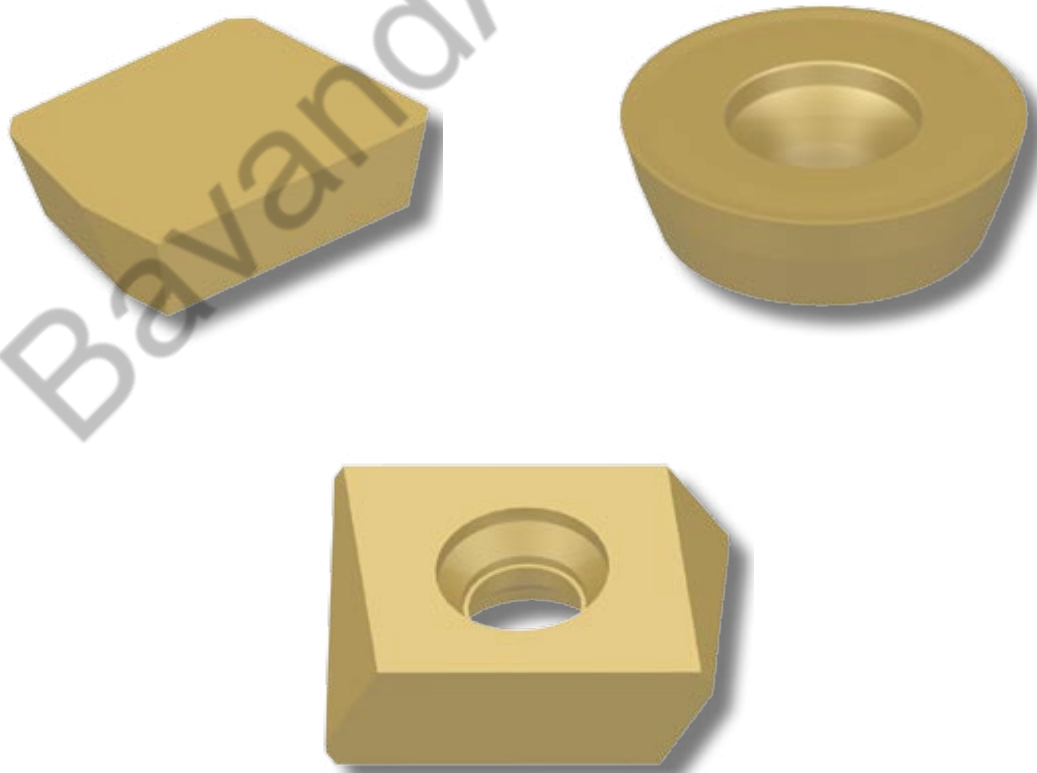

Indexable milling inserts grade classification

B

Indexable  
Milling





## Indexable milling insert naming rules

Üä ää ä!			T ää			
Üä ää ä!	Y ää	Y ää c	Üä ää ä!	Üä ää	Y ää c	Üä ää ä!

Diameter of I.C(mm)	Insert shape						
	C	D	R	S	T	V	W
3.97					06		
5.0			05				
5.56					09		
6.0			06				
6.35	06	07			11	11	
8.0			08				
9.525	09	11	09	09	16	16	06
10.0			10				
12.0			12				
12.7	12	15	12	12	22	22	08
15.875	16		15	15	27		
16.0		19	16				
19.05	19		19	19	33		
20.0			20				
25.0	25	25	25				
25.4			25	25			
31.75			31				
32			32				

Code	Insert thickness(mm)
00	0.79
T0	0.99
01	1.59
T1	1.98
02	2.38
T2	2.58
03	3.18
T3	3.97
04	4.76
T4	4.96
05	5.56
T5	5.95
06	6.35
T6	6.75
07	7.94
09	9.52
T9	9.72
11	11.11
12	12.70

**S P K N**

**15 04 ED S32 L - SM**

Üä ää ä!	Üä ää ä!	Üä ää ä!	Üä ää ä!

Üä ää ä!	Üä ää ä!	Üä ää ä!	Üä ää ä!	Üä ää ä!	Üä ää ä!	Üä ää ä!	Üä ää ä!	Üä ää ä!	Üä ää ä!
A	±0.005	±0.025	±0.025	6.35	±0.08	±0.08	±0.08	±0.11	±0.16
F	±0.005	±0.013	±0.025	9.525	±0.08	±0.08	±0.08	±0.11	±0.16
C	±0.013	±0.025	±0.025	12.7	±0.13	±0.13	±0.13	±0.15	---
H	±0.013	±0.013	±0.025	15.875	±0.15	±0.15	±0.15	±0.18	---
E	±0.025	±0.025	±0.025	19.05	±0.15	±0.15	±0.15	±0.18	---
G	±0.025	±0.025	±0.13	25.4	---	±0.18	---	---	---
J	±0.005	±0.05±0.13	±0.025	6.35	±0.05	±0.05	±0.05	±0.05	---
K	±0.013	±0.05±0.13	±0.025	9.525	±0.05	±0.05	±0.05	±0.05	±0.05
L	±0.025	±0.05±0.13	±0.025	12.7	±0.08	±0.08	±0.08	±0.08	---
M	±0.08±0.18	±0.05±0.13	±0.13	15.875	±0.10	±0.10	±0.10	±0.10	---
N	±0.08±0.18	±0.05±0.13	±0.025	19.05	±0.10	±0.10	±0.10	±0.10	---
U	±0.13±0.38	±0.08±0.25	±0.13	25.4	---	±0.13	---	---	±0.13

Wiper	
A 45°	A 3°
D 60°	B 5°
E 75°	C 7°
F 85°	D 15°
P 90°	E 20°
Z Others	F 25°
	G 30°
	N 0°
	P 11°
	Z Others

Chamfer(mm)	
0-5°	0-0.10
1-10°	1-0.15
2-15°	2-0.20
3-20°	3-0.25
4-25°	4-0.30
5-30°	5-0.35
	6-0.40
	7-0.45

Chipbreaker code

Cutting direction	
R	Right hand
L	Left hand
N	Neutral



# Milling

Indexable milling cutter

## RP

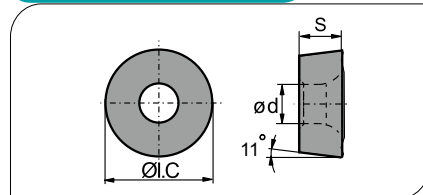

Shape	Type	Dimension(mm)			Coated cemented carbide												Cemented carbide								
		Ø I.C	S	d	P			M			K						JP302	JP402	JK001	JK101	JK202				
					JT4030	JT4040	JT4330	JT4340	JPP302	JT1015	JT1025	JT1035	JT1125	JT1225	JT3105	JT3205	JT3115	JT3215	JT3125	JT3225					
	RPMW0802MO	8	2.38	3.4	☆				○	★															
	RPMW08T2MO	8	2.58	3.4	☆				○	★			☆												
	RPMW10T3MO	10	3.97	4.4	☆				○	★			☆												
	RPMW1204MO	12	4.76	4.4	☆				○	★			☆												

★Recommended grade for stock ●Optional grade for stock ○Make-to-order

## SD

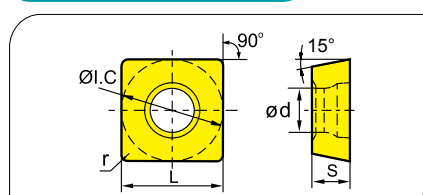

Shape	Type	Dimension(mm)						Coated cemented carbide												Cemented carbide							
		L	Ø I.C	S	d	r		P			M			K						JP302	JP402	JK001	JK101	JK202			
							JT4030	JT4040	JT4330	JT4340	JPP302	JT1015	JT1025	JT1035	JT1125	JT1225	JT3105	JT3205	JT3115	JT3215	JT3125	JT3225					
	SDMT090308	9.525	9.525	3.18	4.4	0.8	○	☆	★	○			★									★		☆			

★Recommended grade for stock ●Optional grade for stock ○Make-to-order

## SD

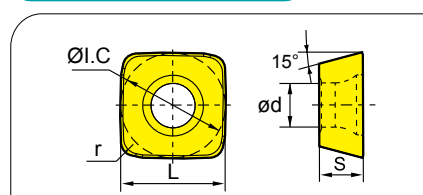

Shape	Type	Dimension(mm)						Coated cemented carbide												Cemented carbide							
		L	Ø I.C	S	d	r		P			M			K						JP302	JP402	JK001	JK101	JK202			
							JT4030	JT4040	JT4330	JT4340	JPP302	JT1015	JT1025	JT1035	JT1125	JT1225	JT3105	JT3205	JT3115	JT3215	JT3125	JT3225					
	SDMT09T312-SM	9.525	9.525	3.18	4.4	1.2	○	☆	★				★									★		☆			
	SDMT120412-SM	12.7	12.7	4.76	4.4	1.2	○	☆	★				★									★		☆			

★Recommended grade for stock ●Optional grade for stock ○Make-to-order

Indexable milling cutter

# Milling

## SE

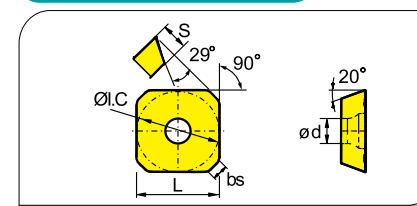

Shape	Type	Dimension(mm)						CVD coating					PVD coating					Cermet	Cemented carbide							
		L	Ø I.C	S	ød	bs	R	JT4030	JT4040	JT4330	JT4340	JT3105	JT3115	JT3125	JT1105	JT1025	JT1125	JT1135	JT1225	JT1035		JP302	JP402	JK101	JK202	
	SEET12T3-SF	13.4	13.4	3.97	4.1	2.55		●	★						★	○										
	SEET12T3-MF	13.4	13.4	3.97	4.1	2.55			★		○			★	○	○										
	SEET12T3-BF	13.4	13.4	3.97	4.1	2.55			★						○	○										
	SEET12T3-FM	13.4	13.4	3.97	4.1	2.55		●	★	★		○			★	★										
	SEET12T3-MM	13.4	13.4	3.97	4.1	2.55			★		○	★			★	○										
	SEET12T3-BM	13.4	13.4	3.97	4.1	2.55			★						○	★										
	SEET12T3-SR	13.4	13.4	3.97	4.1	2.55		●	★	★		○			★	★										
SEET12T3-MR	13.4	13.4	3.97	4.1	2.55		●		★	★					★											
SEET12T3-AH	13.4	13.4	3.97	4.1	2.55																			★		
SEET12T3-W	17.82	13.4	3.97	4.1	9.46	500		★	●		★			★												

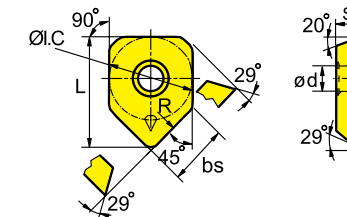

★Recommended grade for stock ●Optional grade for stock ○Make-to-order

B

Indexable Milling

Milling insert

B

Indexable Milling

Milling insert











# Milling

Indexable milling cutter

**LN** □ □

Crankshaft special milling insert

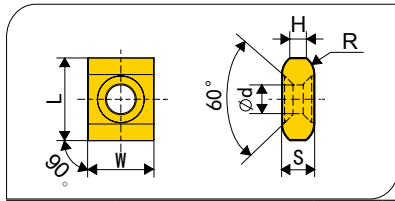

Shape	Type	Dimension(mm)							Coated cemented carbide												Cemented carbide						
		L	W	S	a	R	d		P			M			K						JK202	JK101	JK001				
								JT4030	JT4040	JT4330	JPP302	JT1015	JT1025	JT1035	JT1125	JT3105	JT3205	JT3115	JT3215	JT3125	JT3225	JP302	JP402	JK001	JK101	JK202	
	LNEQ150904-4R30H-T22	15.875	9.525	4.76	60°	3	4.4	☆	☆	★	○	★	☆	★												○	
	LNEQ151104-4R30H-T32	15.875	11.00	4.76	60°	3	5.5	☆	☆	★	○	★	☆	★													○
	LNEQ151206-4R50H-T21	15.875	12.7	6.35	60°	5	5.5	☆	☆	★	○	★	☆	★													○

★Recommended grade for stock ●Optional grade for stock ○Make-to-order

Indexable milling cutter

# Milling

**SN** □ □

Crankshaft special milling insert

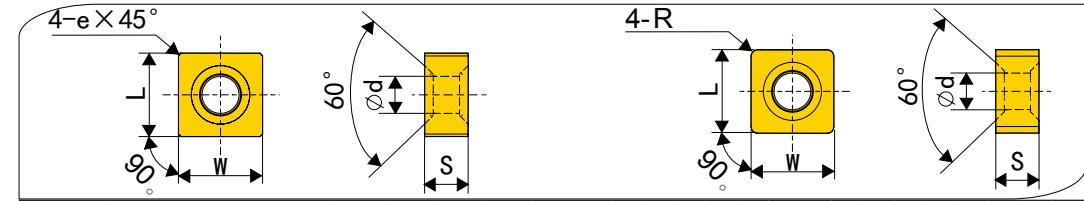

Shape	Type	Dimension(mm)							Coated cemented carbide												Cemented carbide							
		L	W	S	d	R	e		P			M			K						JK202	JK101	JK001					
								JT4030	JT4040	JT4330	JT4340	JT3040	JT1015	JT1025	JT1035	JT1125	JT3105	JT3205	JT3115	JT3215	JT3125	JT3225	JP302	JP402	JK001	JK101	JK202	
	SNEQ1206-403X	12.7	12.7	6.35	5.5		0.3			☆	○	★	☆	★													○	
	SNEQ1206-408X	12.7	12.7	6.35	5.5		0.8			☆	○	★	☆	★														○
	SNEQ120602-4R02X	12.7	12.7	6.35	5.5	0.2				☆	○	★	☆	★														○
	SNEQ120604-4R04X	12.7	12.7	6.35	5.5	0.4				☆	○	★	☆	★														○
	SNEQ120608-4R08X	12.7	12.7	6.35	5.5	0.8				☆	○	★	☆	★														○
	SNEQ1207-4R02																											○

★Recommended grade for stock ●Optional grade for stock ○Make-to-order

**SN** □ □

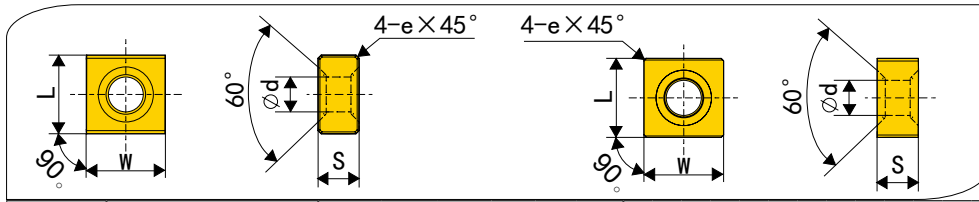

Shape	Type	Dimension(mm)							Coated cemented carbide												Cemented carbide							
		L	W	S	d	e		P			M			K						JK202	JK101	JK001						
								JT4030	JT4040	JT4330	JPP302	JT1015	JT1025	JT1035	JT1125	JT3105	JT3205	JT3115	JT3215	JT3125	JT3225	JP302	JP402	JK001	JK101	JK202		
	SNEQ1206-405-T40	12.7	12.7	6.35	5.5	0.5	☆	☆	★	○	★	☆	★															○
	SNEQ1206A-405-T33	12.7	12.7	6.35	4.4	0.5	☆		★	○	★	☆	★															○
	SNEQ12A06-403-T33	12.0	12.0	6.35	4.4	0.3	☆		★	○	★	☆	★															○
	SNEQ14A06-405-T32	12.0	12.0	6.35	4.4	0.5	☆		★	○	★	☆	★															○
	SNEQ1206-405X-T40	12.7	12.7	6.35	5.5	0.5	☆		★	○	★	☆	★															○
	SNEQ1206A-405X-T33	12.7	12.7	6.35	4.4	0.5	☆		★	○	★	☆	★															○
	SNEQ12A06-403X-T33	12.0	12.0	6.35	4.4	0.3	☆		★	○	★	☆	★															○
	SNEQ14A06-405X-T32	12.0	12.0	6.35	4.4	0.5	☆		★	○	★	☆	★															○

★Recommended grade for stock ●Optional grade for stock ○Make-to-order

**SN** □ □

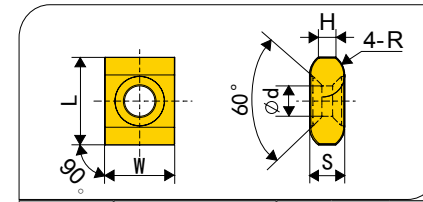

Shape	Type	Dimension(mm)							Coated cemented carbide												Cemented carbide							
		L	W	S	d	R		P			M			K						JK202	JK101	JK001						
								JT4030	JT4040	JT4330	JT4340	JPP302	JT1015	JT1025	JT1035	JT1125	JT3105	JT3205	JT3115	JT3215	JT3125	JT3225	JP302	JP402	JK001	JK101	JK202	
	SNEQ0904-4R30H	9.525	9.525	4.76	5.5	3					☆	○	★	☆	★													○

★Recommended grade for stock ●Optional grade for stock ○Make-to-order

Indexable Milling Milling insert

Indexable Milling Milling insert







# Milling

Indexable milling cutter

**SN□□**

Normal gravity milling insert

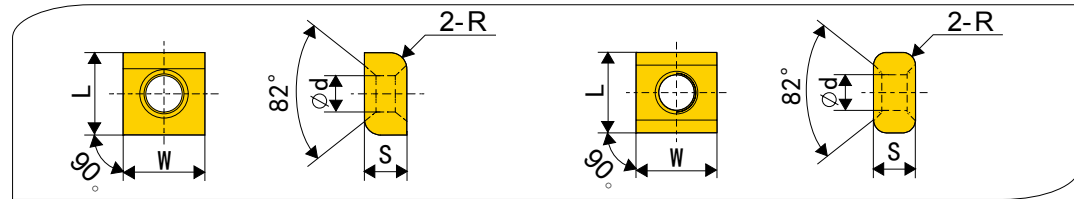

Shape	Type	Dimension(mm)							Coated cemented carbide													Cemented carbide				
		L	W	S	d	a	r		P			M			K							JP302	JK001	JK101	JK202	
□	SNEC1507-2R20-T23	15.875	15.875	7.94	5.50	82°	2	☆	★	○	○	☆									☆	○	○	○	○	○
	SNEC1507-2R20-T24	15.875	15.875	7.94	5.50	82°	5	☆	★	○	○	☆									☆	○	○	○	○	○
	SNEC1507-2R115-T51	15.875	15.875	7.94	5.50	82°	11.5	☆	★	○	○	☆									☆	○	○	○	○	○
□	SNEC1507-4R20-T23	15.875	15.875	7.94	5.50	82°	3.2	☆	★	○	○	☆									☆	○	○	○	○	○

★Recommended grade for stock ●Optional grade for stock ○Make-to-order

Indexable milling cutter

# Milling

**SN□□**

Normal gravity milling insert

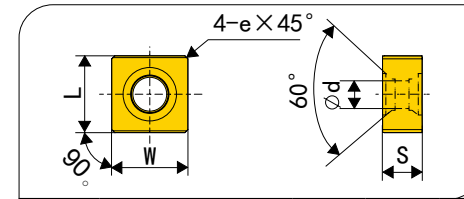

Shape	Type	Dimension(mm)						Coated cemented carbide													Cemented carbide					
		L	W	S	d	R		P			M			K							JP302	JK001	JK101	JK202		
□	SNEQ1106-403X-T22	15.875	15.875	7.94	5.50		○	☆	○	○	☆										☆	○	○	○	○	○
	SNEQ1708A-416X	15.875	15.875	7.94	5.50		○	☆	○	○	☆										☆	○	○	○	○	○

★Recommended grade for stock ●Optional grade for stock ○Make-to-order

**SN□□**

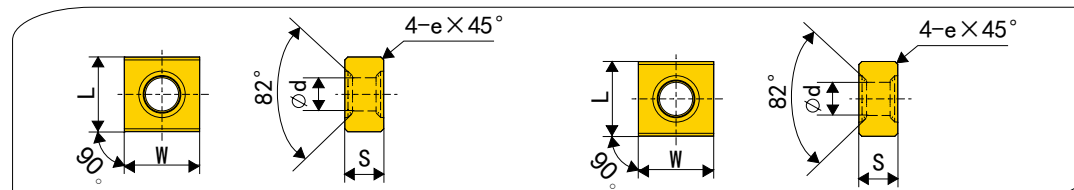

Shape	Type	Dimension(mm)						Coated cemented carbide													Cemented carbide					
		L	W	S	d	e		P			M			K							JP302	JK001	JK101	JK202		
□	SNEC1507-400	15.875	15.875	7.94	5.50	0.00	☆	★	○	○	☆										☆	○	○	○	○	○
	SNEC1507-408	15.875	15.875	7.94	5.50	0.80	☆	★	○	○	☆										☆	○	○	○	○	○
□	SNEC1507-408-T34	15.875	15.875	7.94	5.50	0.80	☆	★	○	○	☆										☆	○	○	○	○	○
	SNEC1507-407-T12	15.875	15.875	7.94	5.50	0.70	☆	★	○	○	☆										☆	○	○	○	○	○

★Recommended grade for stock ●Optional grade for stock ○Make-to-order

**SN□□**

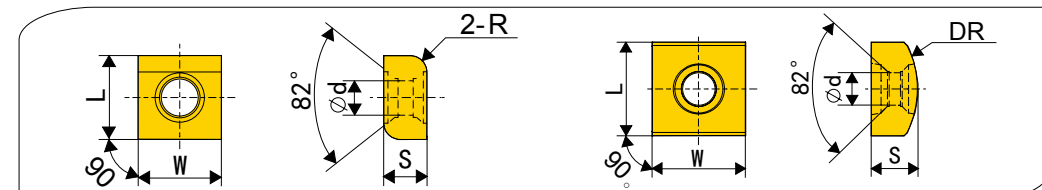

Shape	Type	Dimension(mm)						Coated cemented carbide													Cemented carbide					
		L	W	S	d	R		P			M			K							JP302	JK001	JK101	JK202		
□	SNEC1507-2R32	15.875	15.875	7.94	5.50	3.2	○	☆	○	○	☆										☆	○	○	○	○	○
□	SNEC1507-DR235	15.875	15.875	7.94	5.50	23.5	○	☆	○	○	☆										☆	○	○	○	○	○

★Recommended grade for stock ●Optional grade for stock ○Make-to-order

B

Indexable Milling

Milling insert

B

Indexable Milling

Milling insert



### Difference and selection between down milling and up milling

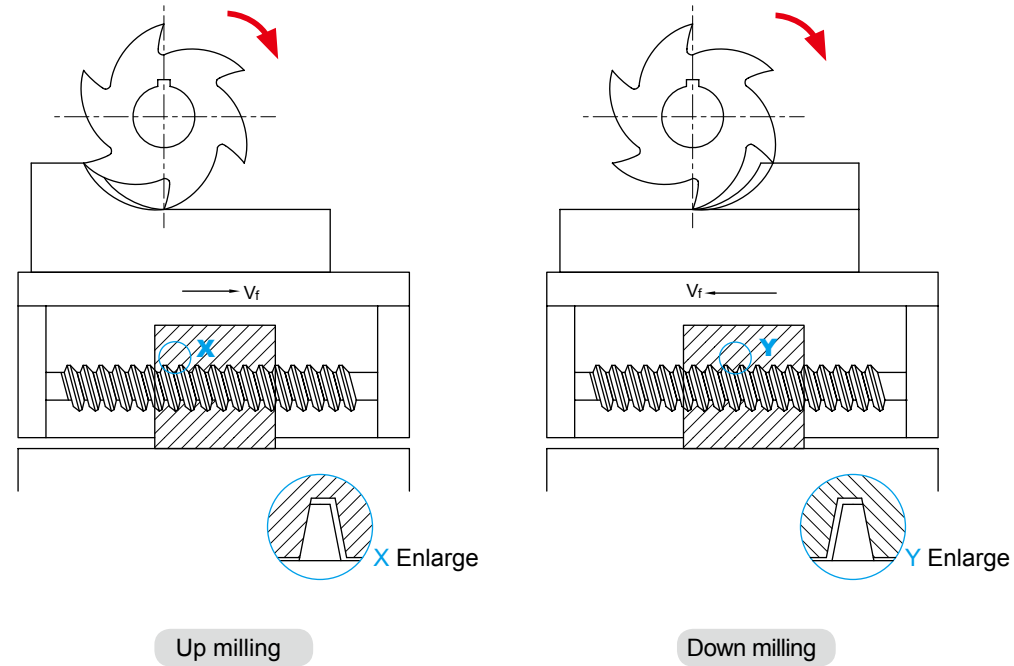

Down milling: the feed direction of workpiece is the same as that of the milling rotation at the connecting position.  
 Up milling: the feed direction of workpiece is opposite to the milling rotation at the connecting position.

In down milling, the major force of cutting edge is compressive stress; in up milling, cutting edge bears the tensile stress. The compressive strength of cemented carbide material is larger than its tensile strength. In down milling, chip becomes thin from thick gradually, cutting edge and workpiece press each other. The friction between edge and workpiece is small, thus can reduce the abrasion of edge, the hardening of workpiece surface and the surface roughness (Ra). In up milling, chip becomes thin gradually. When insert cutting into the workpiece, it generates strong friction and more heat than down milling, and make workpiece surface harden.

In up milling, because horizontal direction of cutting force that milling cutter conduction on workpiece is opposite to the feed direction of workpiece, therefore the lead screw of work table joints closely with one side of screw nut. In down milling, the direction of cutting force is same as the feed direction. When edge's radial force on workpiece is big enough to some extent, the work table will bounce left and right, thus make the gap fall behind. The gap will return to front side along with the continuing rotation of lead screw. At this moment the work table stops motion, however it will bounce left and right again when the radial cutting force is big enough to some extent again. The periodical bounce of work table will cause poor surface quality of workpiece and tool breakage.

When use end mills for down milling, every time the edges begin the cutting at workpiece surface, therefore end mills are not suitable for machining the workpiece with the hardened surface. Up milling is recommended for milling the thin-wall components or square milling with the demand of high precision.

### Pitch selection

Pitch is the distance between one point on one cutting edge and the same point on the next edge. Milling cutters are mainly classified into coarse, close and extra close pitches.

Stability of operation		
L (Low)	M (Medium)	H (High)
<b>Coarse pitch</b> 	<b>Close pitch</b> 	<b>Extra close pitch</b> 
When the milling width is equal to diameter of cutter, the machining system is stable and main power of machine is sufficient, selecting coarse pitch can achieve high productive efficiency.	General milling function and multiple mixed productions	When the milling width is less than diameter of cutter, cutting by maximum edges can achieve high productive efficiency.

### Approach angle selection

The approach angle is composed by insert and tool body, chip thickness, cutting forces and tool-life are affected especially by the approach angle and spreads the cutting area between cutting edge and workpiece for a given feed rate.

A smaller approach angle also guarantee that it is stable entering into or exiting workpiece, to protect the cutting edge and extend tool life. However this will increase higher axial cutting forces on the workpiece, thus is not suitable for machining thin workpiece such as thin plate.

Approach angle	Feed rate per tooth	maximum cutting depth
90°	$f_z$	$h_{ex} = f_z \times \sin \alpha$
75°	$f_z$	$h_{ex} = 0.96 \times f_z$
60°	$f_z$	$h_{ex} = 0.86 \times f_z$
45°	$f_z$	$h_{ex} = 0.707 \times f_z$
Round insert	$f_z$	$h_{ex} = \frac{\sqrt{iC^2 \times (iC - 2a_p)^2}}{iC} \times f_z$

### General formule

$V_c$  : Cutting speed(m/min)     $V_f$  : Feed rate of worktable(feed speed)(mm/min)     $D_c$  : Nominal diameter of milling tool(mm)  
 $f_z$  : Feed rate per tooth(mm/z)     $n$  : Spindle speed(rev/min)  
 $\pi$  : Circumference ratio=3.14  
 $z_n$  : Tooth NO.     $T_c$  : Machining time(min)  
 $Q$  : Metal removal rate(cm<sup>3</sup>/min)  
 $f_r$  : Feed rate per revolution(mm/rev)     $L$  : Real cutting distance(mm)

● Cutting speed

$$V_c = \frac{\pi \times D_c \times n}{1000} \text{ (m/min)}$$

● Spindle speed

$$n = \frac{1000 \times V_c}{\pi \times D_c} \text{ (rev/min)}$$

● Feed rate of worktable(feed speed)

$$V_f = f_z \times n \times z_n \text{ (mm/min)}$$

● Feed rate per tooth

$$f_z = \frac{V_f}{n \times Z_n} \text{ (mm/z)}$$

● Feed rate per revolution

$$f_n = \frac{V_f}{n} \text{ (mm/rev)}$$

● Machining time

$$T_c = \frac{L}{V_f} \text{ (min)}$$

● Metal removal rate

$$Q = \frac{a_p \times a_e \times V_f}{1000} \text{ (cm}^3\text{/min)}$$

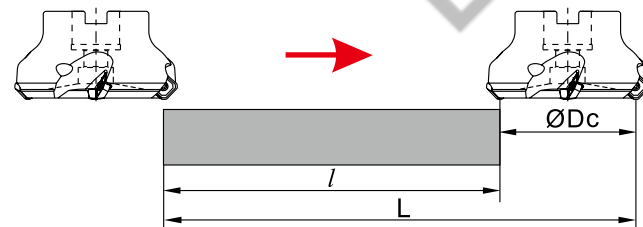
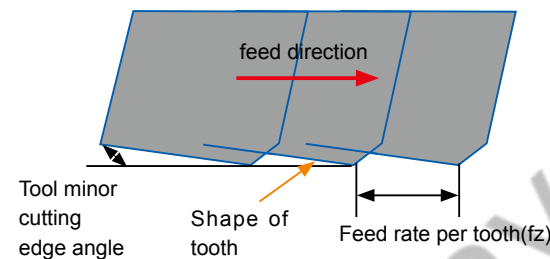
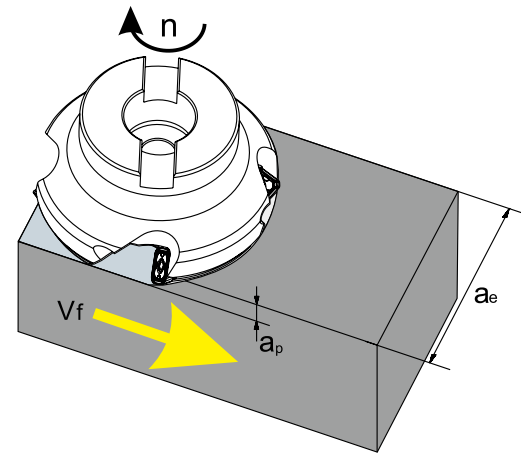

### Function of each part in face milling

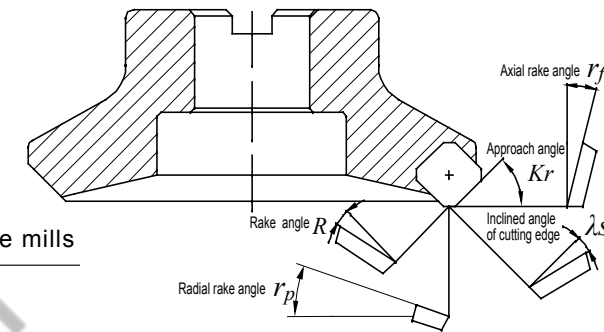

Main angles of face mills

#### Main angles of face mills

Name	Function	Effect
Axial rake angle $r_f$	Determining the chip direction	Negative angle: good chip removal performance
Radial rake angle $r_p$	Determining whether the cutting is light and fast or not	Positive angle: good chip removal performance
Approach angle $K_r$	Determining the chip direction	$K_r \uparrow$ , chip thickness $\uparrow$ ; $K_r \downarrow$ , chip thickness $\downarrow$ ;
Rake angle $R$	Determining whether the cutting is light and fast or not	Poor cutting performance, high strength of cutting edge (-) $\leftarrow 0 \rightarrow$ (+)    Good cutting performance, low strength of cutting edge
Inclined angle of cutting edge $\lambda_S$	Determining the chip direction	Poor cutting performance, high strength of cutting edge (-) $\leftarrow 0 \rightarrow$ (+)    Good cutting performance, low strength of cutting edge

#### Characteristics of different rake angles combined

		Double positive	Double negative	positive, one negative
Negative rake Angle				
0° rake Angle				
Positive rake angle				
Axial rake angle		+	-	+
Radial rake angle		+	-	-
Applicable material machined	<b>P</b>	✓		✓
	<b>M</b>	✓		✓
	<b>K</b>		✓	✓
	<b>N</b>	✓		
	<b>S</b>	✓		



### ■ Cutting performances of different approach angles

Approach angle	45°	75°	90°
Schematic diagram			
Instruction	Axial force is the largest. It will bend when machining thin-wall workpiece, and reduces the precision of workpiece. It is benefit to avoid fringe breakage of workpiece when machining cast iron.	The main purpose is to resolve the radial cutting force, it is often used for general face milling.	The axial force is zero in theory, suitable for milling thin plate workpiece.

### Wiper insert

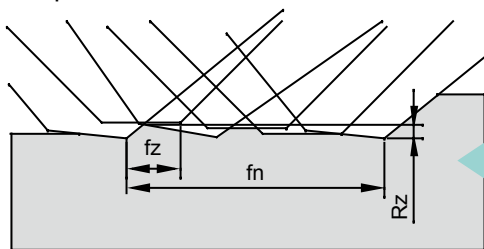

It has axial and radial run out because of tools and inserts exist manufacturing tolerance. The axial runout lead to poor surface roughness.

### Solution

Assembling wiper insert

### Usage

The wiper insert must protrude below the other insert by 0.03-0.05mm at axial direction, only that the wiping function can take into effect. Generally speaking, a cutter can just assemble only one wiper insert. If the diameter of cutter is much bigger or cutter's feed rate per revolution is bigger than the length of wiper edge, 2 to 3 wiper inserts can be assembled.

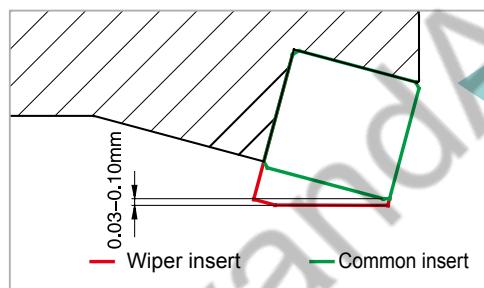

### ■ Selection of cutting width and tool cutting diameter in face milling

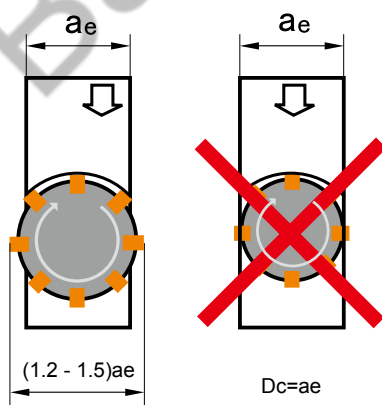

Dc: Tool cutting diameter  
ae: Cutting width

Generally speaking, the relation between cutting width and tool cutting diameter is  $D_c = (1.2 - 1.5) a_e$ . In the machining practice, it need to avoid coincidence of tool center and workpiece center as much as possible.

# General technical information

## Cutting tool used in security matters needing attention

Risk	Measure
Direct contact with sharp cutting edge may cause harm to human body	When you install or remove the cutting tool in the machine tool, please use gloves and other protective labor insurance supplies.
Inappropriate use tool can lead to the breakage, attachment, cause damage	Read the sample and safety standards before use
	Please use the protective glasses and protective clothing
Excessive wear and dramatic impact the cutting resistance, can lead to rupture and the splash, cause harm to the operator	Replace the excessive wear of cutting tool in a timely manner
	Please use the protective glasses and protective clothing.
In the process of cutting chip may cause burns and scratches to the people	Use tools such as forceps to remove scraps in a timely manner
	Please use the protective glasses and protective clothing and protective glove
Sparks in cutting process and high temperature chip is in danger of fire and explosion.	Remove flammable items in the cutting area
	Please get everything ready for fire extinguishing equipment
Speed of machine tools such as fixture balance difference caused by violent vibration, result in tool breakage.	Before cutting, check whether the device is loose or abnormal sound
	Please use the protective glasses and protective clothing
The defects such as burrs on the work piece is very sharp, easy to scratch the body	Please don't touch the burr on the work piece
	Please use the protective gloves and protective clothing
No clamp work piece processed directly causes tool breakage and splash of work piece.	Must be firmly clamp the work piece
	Please use the protective glasses and protective clothing
In the insert or insert attachments were not tightened properly under the situation of cutting, tool shed fly out the risk of damage.	Confirmation before processing blades and other accessories have tighten properly with proper tools
With auxiliary tools such as excessive fastening screw pin or shim, insert or with broken splash of danger.	Please don't use auxiliary tools such as casing too tighten
When high speed cutting insert or attachment, likely due to the inertia fall off under the action of centrifugal force.	Please don't use auxiliary tools such as casing too tighten
	Please use the protective glasses and protective clothing
As a result of the milling cutter winger, directly touch may cause scratches	For your safety, under the condition of the blade must contact your protective gloves
Rotary cutting, clothing, gloves, etc. It is easy to ground to the high speed running equipment, causing casualties	When rotate cutting, please don't wear gloves in processing.
	Attention : don't let the clothes contact with the running machine parts
Eccentric rotating or balance tool in spinning processing will produce bad shake vibration damage caused by flying lead to harm	Please use cutting tools within the scope of permissible speed
	Check the balance of mechanical properties
When high speed cutting, high speed flying out of the chip is likely to cause harm	Use safety cover, protection screen, housing, etc
	Please use the protective glasses and protective clothing and gloves
With minimal cutting tools for drilling, easy to cause break splash and unable to remove the cutting tool	Reduce the vibration of the cutting tool and under appropriate speed processing
	Please use the protective glasses and protective clothing and gloves
The improper use, will cause the acceleration damage of machine tools and cutting tools, and other hazards.	Please use according to instructions and regulations

Remark: if without our permission, without authorization to modify tool caused by the accident, the company is not responsible for

# General technical information

## Diameter of thread bottom hole

### The metric system common thread

Thread Code	Recommended bottom hole diameter(mm)
M3×0.5	2.5
M3.5×0.6	2.9
M4×0.7	3.3
M5×0.8	4.2
M6×1.0	5.0
M7×1.0	6.0
M8×1.25	6.75
M9×1.25	7.75
M10×1.5	8.5
M11×1.5	9.5
M12×1.75	10.25
M14×2.0	12.0
M16×2.0	14.0
M18×2.5	15.5
M20×2.5	17.5
M24×3.0	21.0
M27×3.0	24.0
M30×3.5	26.5

### metric fine thread

Thread Code	Recommended bottom hole diameter(mm)	Thread Code	Recommended bottom hole diameter(mm)
M3×0.35	2.65	M14×1.5	12.5
M3.5×0.35	3.15	M14×1.0	13.0
M4×0.5	3.5	M15×1.5	13.5
M4.5×0.5	4.0	M15×1.0	14.0
M5×0.5	4.5	M16×1.5	14.5
M5.5×0.5	5.0	M16×1.0	15.0
M6×0.75	5.25	M17×1.5	15.5
M7×0.75	6.25	M17×1.0	16.0
M8×1.0	7.0	M18×2.0	16.0
M8×0.75	7.25	M18×1.5	16.5
M9×1.0	8.0	M18×1.0	17.0
M9×0.75	8.25	M20×2.0	18.0
M10×1.25	8.75	M20×1.5	18.5
M10×1.0	9.0	M20×1.0	19.0
M10×0.75	9.25	M22×2.0	20.0
M11×1.0	10.0	M22×1.5	20.5
M11×0.75	10.25	M22×1.0	21.0
M12×1.5	10.5	M24×2.0	22.0
M12×1.25	10.75	M24×1.5	22.5
M12×1.0	11.0	M24×1.0	23.0

# General technical information

## Surface roughness

Surface roughness is refers to the processed surface of small spacing and small peak valley roughness. Surface roughness has close relation with the properties of mechanical parts, abrasion resistance, working accuracy and corrosion resistance, impact to the machine or equipment reliability and life expectancy.

variety	Code	computing method	Calculation method (figure)
Profile arithmetic average error	Ra	<p>Within the sampling length <math>l</math> contour offset distance absolute value of the arithmetic average</p> $R_a = \frac{1}{l} \int_0^l  y(x)  dx$ <p>Type in the contour offset <math>y</math> refers to the distance between the ontour points and the the reference line. Reference line for least squares line <math>O</math> outline. The line dividing profile and make it within the sampling length profile deviation from the line of sum of squares to a minimum.</p>	
Ten point height of irregularities	Rz	<p>Within the sampling length <math>l</math> of the outline of the five biggest peak height and the outline of the five biggest deep valley of the average the sum of the average</p> $R_z = \frac{\sum_{i=1}^5 y_{pi} + \sum_{i=1}^5 y_{vi}}{5}$ <p>Type: <math>y_{pi}</math> is the outline of the <math>i</math>th a maximum peak height, <math>y_{vi}</math> is one of the largest outline the <math>i</math>th a deep valley. Outline of the maximum height <math>R_y</math>: peak within the sampling length <math>l</math> contour line and contour of the distance between the bottom line.</p>	
Maximum height of the profile	Ry	<p>Peak within the sampling length <math>l</math> contour line and the contour of the distance between the bottom line. Outline the summit line is parallel to the baseline and peak by contour line; Outline the bottom line is parallel to the baseline and low by contour lines.</p>	

Sampling length  $l$  and assess value of length  $l_n$

$R_a / \mu m$	$R_z / \mu m$	$l/mm$	$l_n=5l /mm$
$\geq 0.008 \sim 0.02$	$\geq 0.025 \sim 0.10$	0.08	0.4
$> 0.02 \sim 0.1$	$> 0.1 \sim 0.50$	0.25	1.25
$> 0.1 \sim 0.2$	$> 0.50 \sim 10.0$	0.8	4.0
$> 0.2 \sim 10.0$	$> 10.0 \sim 50.0$	2.5	12.5
$> 10.0 \sim 80.0$	$> 50 \sim 320$	8.0	40.0

# General technical information

## Material comparison table

### Material comparison table

ISO	Country and standard										
	China	America	Germany		England		Sweden	France	Italy	Spain	Japan
	GB	AISI/SAE	W. -nr	DIN	BS	EN	SS	AFNOR	UNI	UNE	JIS
P	<b>Structural steel</b>										
	15	1015	1.0401	C15	080M15	-	1350	CC12	C15C16	F.111	-
	20	1020	1.0402	C22	050A20	2C	1450	CC20	C20C21	F.112	-
	35	1035	1.0501	C35	060A35	-	1550	CC35	C35	F.113	-
	45	1045	1.0503	C45	080M40	-	1650	CC45	C45	F.114	-
	55	1055	1.0535	C55	070M55	-	1655	-	C55	-	-
	60	1060	1.0601	C60	080A62	43D	-	CC55	C60	-	-
	Y15	1213	1.7015	9SMn28	230M07	-	1912	S250	CF9SMn28	11SMn28	SUM22
	-	12L13	1.0718	9SMnPb28	-	-	1914	S250Pb	CF9MnPb28	11SMnPb28	SUM22L
	-	-	1.0722	10SPb20	-	-	-	10PbF2	CF10Pb20	10SPb20	-
	-	1140	1.0726	35S20	212M36	8M	1957	35MF4	-	F210G	-
	Y13	1215	1.0736	9SMn36	240M07	1B	-	S300	CF9SMn36	12SMn35	-
	-	12L14	1.0737	9SMnPb36	-	-	1926	S300Pb	CF9SMnPb36	12SMnP35	-
	55Si2Mn	9255	1.0904	55Si9	250A53	45	2085	55S7	55Si8	56Si7	-
	-	9262	1.0961	60SiCr7	-	-	-	60SC7	60SiCr8	60SiCr8	-
	15	1015	1.1141	Ck15	080M15	32C	1370	XC12	C16	C15K	S15C
	40Mn	1039	1.1157	40Mn4	150M36	15	-	35M5	-	-	S25C
	25	1025	1.1158	Ck25	-	-	-	-	-	-	S25C
	35Mn2	1335	1.1167	36Mn5	-	-	2120	40Mn5	-	36Mn5	SMn438(H)
	30Mn	1330	1.1170	28Mn6	150M28	14A	-	20M5	C28Mn	-	SCMn1
	35Mn	1035	1.1183	Cf35	060A35	-	1572	XS38TS	C36	-	S35C
	Ck45	1045	1.1191	45	080M46	-	1672	XC42	C45	C45K	S45C
	55	1055	1.1203	Ck55	070M55	-	-	XC45	C50	C55K	S55C
	50	1050	1.1213	Cf53	060A52	-	1674	XC48TS	C53	-	S50C
	60Mn	1060	1.1221	Ck60	080A62	43D	1678	XC60	C60	-	S58C
	-	1095	1.1274	Ck101	060A96	-	1870	-	-	-	SUP4
	-	-	1.3401	X120Mn12	Z120M12	-	-	X120M12	XG120Mn12	X120Mn12	SCMnH1
	Gr15;45Gr	52100	1.3505	100Cr6	534A99	31	2258	100C6	100Cr6	F.131	SUJ2
	-	ASTM A204Gr.A	1.5415	15Mo3	1501-240	-	2912	15D3	16Mo3KW	16Mo3	-
	-	4520	1.5426	16Mo5	1503-245-420	-	-	-	16Mo5	16Mo5	-
-	ASTM A350LF5	1.5622	14Ni6	-	-	-	16N6	14Ni6	15Ni6	-	
-	ASTM A353	1.5662	X8Ni9	1501-509;510	-	-	-	X10Ni9	XBNI09	-	

# General technical information

## Material comparison table

ISO	Country and standard										
	China	America	Germany		England		Sweden	France	Italy	Spain	Japan
	GB	AISI/SAE	W. -nr	DIN	BS	EN	SS	AFNOR	UNI	UNE	JIS
P	<b>Structural steel</b>										
	-	2515	1.5680	12Ni19	-	-	-	Z18N5	-	-	-
	-	3135	1.5710	36NiCr6	640A35	111A	-	35NC6	-	-	SNC236
	-	3415	1.5732	14NiCr10	-	-	-	14NC11	16NiCr11	15NiCr11	SNC415(H)
	-	3415 3310	1.5752	14NiCr14	655M13 655A12	36A	-	12NC15	-	-	SNC815(H)
	-	9840	1.6511	36CrNiMo4	816M40	110	-	40NCD3	38CrNiMo4(KB)	35CrNiMo4	-
	-	8620	1.6523	21NiCrMo2	850M20	362	2503	20NCD2	20NiCrMo2	20NiCrMo2	SNCCM220(H)
	-	8740	1.6546	40NiCrMo2	311-Type7	-	-	-	40NiCrMo2(KB)	40NiCrMo2	SNC240
	40CrNiMoA	4340	1.6582	34CrNiMo6	817M40	24	2541	35NCD6	35CrNiMo6(KB)	-	-
	-	-	1.6587	17CrNiMo6	820A16	-	-	18NCD6	-	14CrNiMo13	-
	15Cr	5015	1.7015	15Cr3	523M15	-	-	12C3	-	-	SCr415(H)
	35Cr	5132	1.7033	34Cr4	530A32	18B	-	32C4	34Cr4(KB)	35Cr4	SCr430(H)
	40Cr	5140	1.7035	41Cr4	530M40	18	-	42C4	41Cr4	42Cr4	SCr440(H)
	40Cr	5140	1.7045	42Cr4	-	-	2245	-	-	42Cr4	SCr440
	18CrMn	5115	1.7131	16MnCr15	(527M20)	-	2511	16MC5	16MnCr15	16MnCr15	-
	20CrMn	5155	1.7176	55Cr3	527A60	48	-	55C3	-	-	SUP9(A)
	30CrMn	4130	1.7218	25CrMo4	1717CDS110	-	2225	25CD4	25CrMo4(KB)	55Cr3	SCM420; SCM430
	35CrMo	4137;4135	1.7220	34CrMo4	708A37	19B	2234	35CD4	35CrMo4	34CrMo4	SCM432; SCRRM3
	40CrMoA	4140;4142	1.7223	41CrMo4	708M40	19A	2244	42CD4TS	41CrMo4	41CrMo4	SCM440
	42CrMo 42CrMnMo	4140	1.7225	42CrMo4	708M40	19A	2244	42CD4	42CrMo4	42CrMo4	SCM440(H)
	-	-	1.7262	15CrMo5	-	-	2216	12CD4	-	12CrMo4	SCM415(H)
	-	ASTM A182 F11;F12	1.7335	13CrMo44	1501-620Gr.27	-	-	15CD3.5; 15CD4.5	14CrMo44	14CrMo45	-
	-	-	1.7361	32CrMo12	722M24	40B	2240	30CD12	32CrMo12	F.124.A	-
	-	ASTM A182 F.22	1.7380	10CrMo910	1501-622Gr.31;45	-	2218	12CD9;10	12CrMo9,10	TU.H	-
	-	-	1.7715	14MoV63	1503-660-440	-	-	-	-	13MoCrV6	-
	50CrVA	6150	1.8159	50CrV4	735A50	47	2230	50CV4	50CrV4	51CrV4	SUP10
	-	-	1.8509	41CrAlMo7	905M39	41B	2940	40CAD6,12	41CrAlMo7	41CrAlMo7	-
	-	-	1.8523	39CrMoV139	897M39	40C	-	-	36CrMoV12	-	-

# General technical information

## Material comparison table

ISO	Country and standard										
	China	America	Germany		England		Sweden	France	Italy	Spain	Japan
	GB	AISI/SAE	W. -nr	DIN	BS	EN	SS	AFNOR	UNI	UNE	JIS
P	<b>Chisel tool steel</b>										
	T10	W.110	1.1545	C105W1	-	-	1880	Y1105	C98KU C100KU	F.515 F.516	-
	T12A	W.112	1.1663	C125W	-	-	-	Y2120	C120KU	(C120)	SK2
	CrV;9SiCr	L3	1.2067	100Cr6	BL3	-	-	Y100C6	-	100Cr6	-
	Cr12	D3	1.2080	X210Cr12	BD3	-	-	Z200Cr12	X210Cr13KU X250Cr12KU	X210Cr12	SKD1
	4Cr5MoVSi	H13	1.2344	X40CrMoV5 1	BH13	-	2242	Z40CDV5	X35CrMoV05KU X40CrMoV51KU	X40CrMoV5	SKD61
	Cr6WV	A2	1.2363	X100CrMoV5 1	BA2	-	2260	Z100CDV5	X100CrMoV51KU	X100CrMoV5	SKD12
	CrWMo	-	1.2419	105WCr6	-	-	2140	105WC13	10WCr6 107WCr5KU	105WCr5	SKS31 SKS2 SKS3
	Cr12W	-	1.2436	X210CrW12	-	-	2312	-	X215CrW12 1KU	X210CrW12	SKD2
	5CrNiMo	S1	1.2542	45WCrV7	BS1	-	2710	-	45WCrV8KU	45WCrSi8	-
	3Cr2W8V	H21	1.2581	X30WCrV9 3 X30WCrV93KU	BH21	-	-	Z30WCV9	X28W09KU X30WCrV9 3KU	X30WCrV9	SKD5
	Cr12MoV	-	1.2601	X165CrMoV 12	-	-	2310	-	X165CrMoV12KU	X160CrMoV12	SKD11
	5CrNiMo	L6	1.2713	55NiCrMoV6	-	-	-	55NCDV7	-	F.250.S	SKT4
	V	W210	1.2833	100V1	BW2	-	-	Y1105V	-	-	SKS43
	W6Mo5Cr4V2Co5	-	1.3243	S6-5-2-5	-	-	2723	Z85WDKCV	HS6-5-2-5	HS6-5-2-5	SKH55
	W18Cr4VCo5	T4	1.3255	S18-1-2-5	BT4	-	-	Z80WKCV 10-05-04-01	X78WCo1805KU	HS18-1-1-5	SKH3
	W6Mo5Cr4V2	M2	1.3343	S6-5-2	BM2	-	2722	Z85WDCV 06-05-04-02	X82WMo0605KU	HS6-5-2	SKH9
	-	M7	1.3348	S2-9-2	-	-Z-	2782	Z100WCWV 09-02-04-02	HS2-9-2	HS2-9-2	-
	W18Cr4V	T1	1.3355	S18-0-1	BT1	-	-	Z80WCV 18-04-01	X75W18KU	HS18-0-1	SKH2
	W6Mo5Cr4V3	M3	-	S6-5-3	-	-	-	-	-	-	SKH52
	-	M42	-	-	BM42	-	-	-	-	-	SKH59

# General technical information

## Material comparison table

ISO	Country and standard					Main application
	China	America	Germany	Japan	Datong (Japan)	
	GB	AISI/SAE	DIN	JIS	DAIDO	
P	<b>Plastic die steel</b>					
	-	P20 mod.	-	-	PX5N	Mass production with large mirror mould. Auto tail lamp, mirror before the shell baffle, cameras, home appliances, etc
	-	-	-	-	NAK55	High precision mirror mould. Camera, music, cosmetic containers, transparent cover glass, transparent film, etc
	-	-	-	-	NAK80	High mirror high precision mold. Cameras, cosmetic containers, transparent cover, transparent film, etc
	3Cr13	420 mod.	-	SUS420J2 mod.	S-STAR	Super mirror corrosion precision mold. Camera parts, CD, lens, watch case
	<b>Cold-work die steel</b>					
	-	02	-	SKS93	YK30	Stamping mold, gauge, paper knife, auxiliary tools
	9CrWMn	01 mod.	-	SKS3 mod.	GOA	Blanking die, gauge, die, tap, a hole punch
	Cr12MoV	D2	X165CrMoV12	SKD11	DC11	Die, cold, cold die, die forming roll, the punch
	-	D2 mod.	-	SKD11 mod.	DC53	Die, cold, cold die, die forming roll, the punch
	<b>Hot-work die steel</b>					
	4Cr5MoSiV1	H13	X40CrMoV51	SKD61	DHA1	Aluminum die-casting mould, die-casting mould connection parts, stamping dies, hot extrusion die, hot shear blades
	-	-	-	-	DH21	Long-life aluminum die-casting mould
	-	-	-	-	DH31-S	Heavy die casting dies
	-	-	-	-	DH2F	Die mold, plastic mold



# General technical information

## Material comparison table

ISO	Country and standard											
	China	America	Germany		England		Sweden	France	Italy	Spain	Japan	
	GB	AISI/SAE	W.-nr	DIN	BS	EN	SS	AFNOR	UNI	UNE	JIS	
M	<b>Stainless steel</b>											
	0Cr13; 1Cr12	403	1.4000	X6Cr13	403S17	-	2301	Z6C13	X6Cr13	F.3110	SUS403	
	-	-	1.4001	X7Cr14	-	-	-	-	-	F.8401	-	
	1Cr13	410	1.4006	X10Cr13	410S21	56A	2302	Z10C14	X12Cr13	F.3401	SUS410	
	1Cr17	430	1.4016	X6Cr17	430S15	60	220	Z8C17	X8Cr17	F.3113	SUS430	
	2Cr13	410	1.4021	X20Cr13	S62	56B; 56C	-	Z20C13	X20C13	F.3401	SUS410	
	-	-	1.4027	G-X20Cr14	420C29	56B	-	Z20C13M	-	-	SCS2	
	4Cr13	-	1.4034	X46Cr13	420S45	56D	2304	Z40CM Z38C13M	X40Cr14	F.3405	SUS420J2	
	1Cr17Ni2	431	1.4057	X20CrNi172	431S29	57	2321	Z15CNi6.02	X16CrNi16	F.3427	SUS431	
	Y1Cr17	430F	1.4104	X12CrMoS17	-	-	2383	Z10CF17	X10CrS17	F.3117	SUS430F	
	1Cr17Mo	434	1.4113	X6CrMo171	434S17	-	2325	Z8CD17.01	X8CrMo17	-	SUS434	
	-	-	1.4313	X5CrNi134	425C11	-	-	Z4CND13.4M	-	-	SCS5	
	-	-	1.4408	G-X6CrNiMo1810	316C16	-	-	-	-	F.8414	SCS14	
	4Cr9Si2	HW3	1.4718	X45CrSi93	401S45	52	-	Z45CS9	X45CrSi8	F.322	SUH1	
	0Cr13Al	405	1.4724	X10CrAl13	403S17	-	-	Z10C13	X10CrAl12	F.311	SUS405	
	Cr17	430	1.4742	X10CrAl18	430S15	60	-	Z10CAS18	X8Cr17	F.3113	SUS430	
	8Cr20Si2Ni	HNV6	1.4757	X80CrNiSi20	443S65	59	-	Z80CSN20.02	X80CrSiNi20	F.320V	SUH4	
	2Cr25N	446	1.4762	X10CrAl24	-	-	2322	Z10CAS24	X16Cr26	-	SUH446	
	M	<b>Austenitic stainless steel</b>										
		0Cr18Ni9	304	1.4301	X5CrNi1810	304S15	58E	2332	Z6CN18.09	X5CrNi1810	F.3551; F.3541; F.3504	SUS304
		1Cr18Ni9MoZr	303	1.4305	X10CrNiS189	303S21	58M	2346	Z10CNF18.09	X10CrNiS18.09	F.3508	SUS303
		0Cr19Ni10	304L	1.4306	X2CrNi1911	304S12	-	2352	Z2CN18.10	X2CrNi18.11	F.3503	SCS19
		-	-	1.4308	G-X6CrNi189	304C15	-	-	Z6CN18.10M	-	-	SCS13
		Cr17Ni7	301	1.4310	X12CrNi177	-	-	2331	Z12CN17.07	X12CrNi1707	F.3517	SUS301
		-	304LN	1.4311	X2CrNiN1810	304S62	-	2371	Z2CN18.10	-	-	SUS304LN
0Cr19Ni9		304	1.4350	X5CrNi189	304S31	58E	-	Z6CN18.09	X5CrNi1810	-	SUS304	
0Cr17Ni11Mo2		316	1.4401	X5CrNiMo1712	316S16	Z6CND17.11	2347	1.4401	X5CrNiMo1712	F.3543	SUS316	
00Cr17Ni13Mo2		316LN	1.4429	X2CrNiMoN17133	-	-	2375	Z2CND17.13	-	-	SUS316LN	
0Cr27Ni12Mo3		316L	1.4435	X2CrNiMo18143	316S12	-	2353	Z2CDN17.13	X2CrNiMo1713	-	SCS16,	
00Cr19Ni13Mo3		317L	1.4438	X2CrNiMo17133	317S12	-	2367	Z2CND19.15	X2CrNiMo18.16	-	SUS317L	
-		329L	1.4460	X8CrNiMo275	-	-	2324	-	-	-	SUS329L; SCH11; SCS11	
1Cr18Ni9Ti		321	1.4541	X6CrNiTi1810	2337	321S12	58B	Z6CNT18.10	X6CrNiTi1811	F.3553	SUS321	
1Cr18Ni11Nb		347	1.4550	X6CrNiNb1810	347S17	58F	2338	Z6CNNb.18.1	X6CrNiTi1811	F.3552	SUS347	
Cr18Ni12Mo2Ti		316Ti	1.4571	X6CrNiMoTi17122	320S17	58J	2350	Z6NDT17.12	X6CrNiMoTi17	F.3535	-	

# General technical information

## Material comparison table

ISO	Country and standard											
	China	America	Germany		England		Sweden	France	Italy	Spain	Japan	
	GB	AISI/SAE	W.-nr	DIN	BS	EN	SS	AFNOR	UNI	UNE	JIS	
M	<b>Austenitic stainless steel</b>											
	-	-	1.4581	G-X5CrNiMoNb1810	318C7	-	-	Z4CNDNb1812M	XG8CrNiMo18	-	SCS22	
	Cr17Ni12Mo3Nb	318	1.4583	X10CrNiMoNb1812	-	-	Z6CNDNb1713B	X6CrNiMoTiNb17	-	-		
	1Cr23Ni13	309	1.4828	X15CrNiSi2012	309S24	-	-	Z15CNS20.1	-	-	SUH309	
	0Cr25Ni20	310S	1.4845	X12CrNi2521	310S24	-	2361	Z12CN2520	X6CrNi2520	F.331	SUH310	
	Cr15Ni36W3Ti	330	1.4864	X12NiCrSi3616	-	-	-	Z12CNS35.1	-	-	SUH330	
	-	-	1.4865	G-X40NiCrSi3818	330C11	-	-	-	XG50NiCr3919	-	SCH15	
	5Cr2Mn9Ni4N	EV8	1.4871	X53CrMnNiN219	349S54; 321S12	-	58B	-	Z52CMN21.0	X53CrMnNiN219	-	SUH35
	1Cr18Ni9Ti	321	1.4878	X12CrNiTi189	321S320	58C	-	Z6CNT18.12	X6CrNiTi1811	F.3523	SU321	

ISO	Country and standard								
	China	America	Germany	England	Sweden	France	Italy	Spain	Japan
K	<b>Nodular cast iron</b>								
	QT400-18	60-40-18	GGG40	400/17	0717-02	FGS370-17	GS370-17	FGE38-17	FCD400
	QT450-10	65-45-12	--	420/12	--	FGS400-12	GS400-12	FGE42-12	FCD450
	QT500-7	70-50-05	GGG50	500/7	0727-02	FGS500-7	GS500-7	FGE50-7	FCD500
	QT600-3	80-60-03	GGG60	600/7	0732-03	FGS600-2	GS600-2	FGE60-2	FCD600
	QT700-2	100-70-03	GGG70	700/2	0737-01	FGS700-2	GS700-2	FGE70-2	FCD700
	QT800-2	120-90-02	GGG80	800/2	0864-03	FGS800-2	GS800-2	FGE80-2	FCD800
	QT900-2	--	--	900/2	--	--	--	--	--
	<b>Grey cast iron</b>								
	--	NO.60	GG40	--	0140	FGL400	--	--	--
	HT350	NO.50	GG35	350	0135	FGL350	G35	FG35	FC350
	HT300	NO.45	GG30	300	0130	FGL300	G30	FG30	FC300
	HT250	NO.35	GG25	250	0125	FGL250	G25	FG25	FC250
	HT200	NO.30	GG20	200	0120	FGL200	G20	FG20	FC200
	HT150	NO.20	GG15	150	0115	FGL150	G15	FG15	FC150
HT100	--	--	100	0110	--	G10	--	FC100	

# General technical information

## Fit dimension tolerance

### Fit dimension tolerance

Dimension mm		Standard tolerance grade																	
Greater than	To	IT1	IT2	IT3	IT4	IT5	IT6	IT7	IT8	IT9	IT10	IT11	IT12	IT13	IT14	IT15	IT16	IT17	IT18
		μm										mm							
---	3	0.8	1.2	2	3	4	6	10	14	25	40	60	0.1	0.14	0.25	0.4	0.6	1	1.4
3	6	1	1.5	2.5	4	5	8	12	18	30	48	75	0.12	0.18	0.3	0.48	0.75	1.2	1.8
6	10	1	1.5	2.5	4	6	9	15	22	36	58	90	0.15	0.22	0.36	0.58	0.9	1.5	2.2
10	18	1.2	2	3	5	8	11	18	27	43	70	110	0.18	0.27	0.43	0.7	1.1	1.8	2.7
18	30	1.5	2.5	4	6	9	13	21	33	52	84	130	0.21	0.33	0.52	0.84	1.3	2.1	3.3
30	50	1.5	2.5	4	7	11	16	25	39	62	100	160	0.25	0.39	0.62	1	1.6	2.5	3.9
50	80	2	3	5	8	13	19	30	46	74	120	190	0.3	0.46	0.74	1.2	1.9	3	4.6
80	120	2.5	4	6	10	15	22	35	54	87	140	220	0.35	0.54	0.87	1.4	2.2	3.5	5.4
120	180	3.5	5	8	12	18	25	40	63	100	160	250	0.4	0.63	1	1.6	2.5	4	6.3
180	250	4.5	7	10	14	20	29	46	72	115	185	290	0.46	0.72	1.15	1.85	2.9	4.6	7.2
250	315	6	8	12	16	23	32	52	81	130	210	320	0.52	0.81	1.3	2.1	3.2	5.2	8.1
315	400	7	9	13	18	25	36	57	89	140	230	360	0.57	0.89	1.4	2.3	3.6	5.7	8.9
400	500	8	10	15	20	27	40	63	97	155	250	400	0.63	0.97	1.55	2.5	4	6.3	9.7
500	630	9	11	16	22	32	44	70	110	175	280	440	0.7	1.1	1.75	2.8	4.4	7	11
630	800	10	13	18	25	36	50	80	125	200	320	500	0.8	1.25	2	3.2	5	8	12.5
800	1000	11	15	21	28	40	56	90	140	230	360	560	0.9	1.4	2.3	3.6	5.6	9	14
1000	1250	13	18	24	33	47	66	105	165	260	420	660	1.05	1.65	2.6	4.2	6.6	10.5	16.5
1250	1600	15	21	29	39	55	78	125	195	310	500	780	1.25	1.95	3.1	5	7.8	12.5	19.5
1600	2000	18	25	35	46	65	92	150	230	370	600	920	1.5	2.3	3.7	6	9.2	15	23
2000	2500	22	30	41	55	78	110	175	280	440	700	1100	1.75	2.8	4.4	7	11	17.5	28
2500	3150	26	36	50	68	96	135	210	330	540	860	1350	2.1	3.3	5.4	8.6	13.5	21	33

Note

- The basic size greater than 500 mm, IT1 to IT5 standard tolerance value for trial.
- The basic size less than or equal to 1 mm, no IT4 to IT18.

# General technical information

## Fit dimension tolerance

Lower deviation (ei) and upper deviation (es) of axis can be made of axis basic deviation and the standard of tolerance(IT)

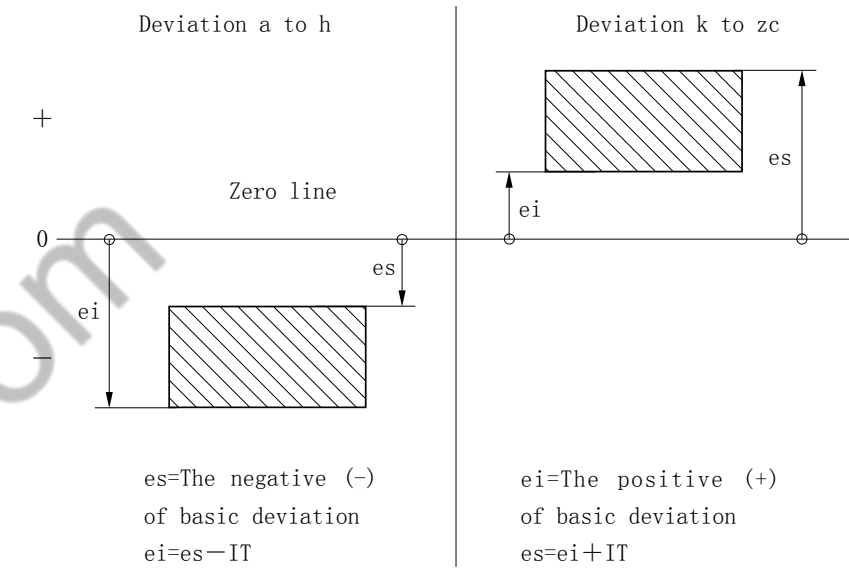

Lower deviation (ei) and upper deviation (es) of hole can be made of hole basic deviation and the standard of tolerance(IT)

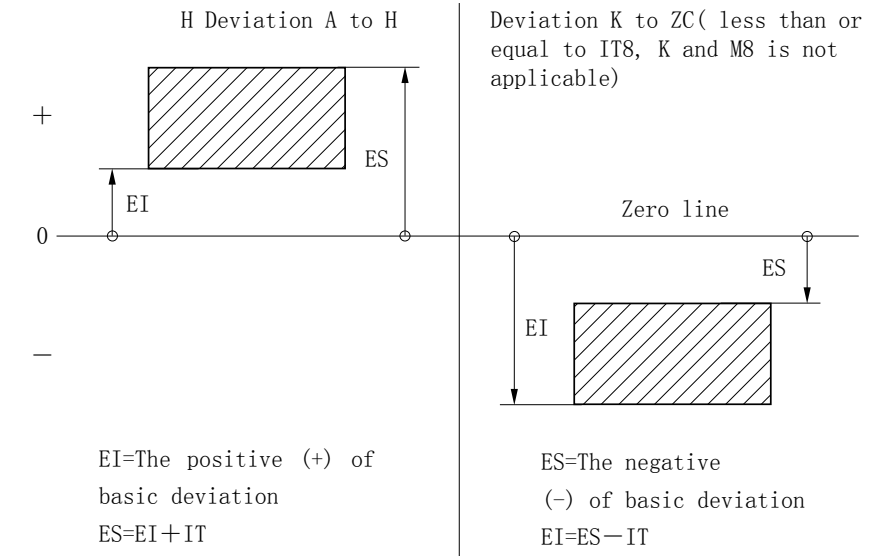

For example: for a  $\emptyset 3$ , tolerance grade for the H7 hole, from the basic principle of hole deviation value in the table to check the size range of tolerance grade class H Lower deviation EI = 0, and tolerance to 7 class corresponding to the standard tolerance of IT =  $10 \mu\text{m}$ , the upper deviation ES = EI + IT =  $10 \mu\text{m}$ .  
hole fit dimension is  $\emptyset 3 \begin{matrix} +0.01 \\ 0 \end{matrix} \text{mm}$ .

# General technical information

## Fit dimension tolerance

### The basic deviation value

Dimension mm		Basic deviation value											
		upper deviation es											
		All the standard tolerance grade											
Greater than	To	a	b	c	cd	d	e	ef	f	fg	g	h	js
---	3	-270	-140	-60	-34	-20	-14	-10	-6	-4	-2	0	
3	6	-270	-140	-70	-46	-30	-20	-14	-10	-6	-4	0	
6	10	-280	-150	-80	-56	-40	-25	-18	-13	-8	-5	0	
10	14	-290	-150	-95		-50	-32		-16		-6	0	
14	18												
18	24	-300	-160	-110		-65	-40		-20		-7	0	
24	30												
30	40	-310	-170	-120		-80	-50		-25		-9	0	
40	50	-320	-180	-130									
50	65	-340	-190	-140		-100	-60		-30		-10	0	
65	80	-360	-200	-150									
80	100	-380	-220	-170		-120	-72		-36		-12	0	
100	120	-410	-240	-180									
120	140	-460	-260	-200									
140	160	-520	-280	-210		-145	-85		-43		-14	0	
160	180	-580	-310	-230									
180	200	-660	-340	-240									
200	225	-740	-380	-260		-170	-100		-50		-15	0	
225	250	-820	-420	-280									
250	280	-920	-480	-300		-190	-110		-56		-17	0	
280	315	-1050	-540	-330									
315	355	-1200	-600	-360		-210	-125		-62		-18	0	
355	400	-1350	-680	-400									
400	450	-1500	-760	-440		-230	-135		-68		-20	0	
450	500	-1650	-840	-480									
500	560					-260	-145		-76		-22	0	
560	630												
630	710					-290	-160		-80		-24	0	
710	800												
800	900					-320	-170		-86		-26	0	
900	1000												
1000	1120					-350	-195		-98		-28	0	
1120	1250												
1250	1400					-390	-220		-110		-30	0	
1400	1600												
1600	1800					-430	-240		-120		-32	0	
1800	2000												
2000	2240					-480	-260		-130		-34	0	
2240	2500												
2500	2800					-520	-290		-145		-38	0	
2800	3150												

Deviation =  $\pm \frac{IT_n}{2}$ , and IT<sub>n</sub> is the number of IT

Note: 1. The basic size less than or equal to 1 mm, basic deviation of a and b are not used.  
2. If tolerance zone js7 to js11, IT<sub>n</sub> number values is odd, the deviation =  $\pm \frac{IT_n-1}{2}$

# General technical information

## Fit dimension tolerance

µm

Basic deviation value																				
lower deviation ei																				
IT5 and IT6	IT7	IT8	IT4 and IT7	≤IT3 >IT7	All the standard tolerance grade															
					j	k	m	n	p	r	s	t	u	v	x	y	z	zn	zb	zc
-2	-4	-6	0	0	+2	+4	+6	+10	+14		+18		+20		+26	+32	+40	+60		
-2	-4		+1	0	+4	+8	+12	+15	+19		+23		+28		+35	+42	+50	+80		
-2	-5		+1	0	+6	+10	+15	+19	+23		+28		+34		+42	+52	+67	+97		
-3	-6		+1	0	+7	+12	+18	+23	+28		+33		+39	+45	+60	+77	+108	+150		
-4	-8		+2	0	+8	+15	+22	+28	+35		+41	+47	+54	+63	+73	+98	+136	+188		
-4	-8		+2	0	+8	+15	+22	+28	+35		+41	+48	+55	+64	+75	+88	+118	+160	+218	
-5	-10		+2	0	+9	+17	+26	+34	+43		+48	+60	+68	+80	+94	+112	+148	+200	+274	
-5	-10		+2	0	+9	+17	+26	+34	+43		+48	+70	+81	+97	+114	+136	+180	+242	+325	
-7	-12		+2	0	+11	+20	+32			+41	+53	+66	+87	+102	+122	+144	+172	+226	+300	+405
-7	-12		+2	0	+11	+20	+32			+43	+59	+75	+102	+120	+146	+174	+210	+274	+360	+480
-9	-15		+3	0	+13	+23	+37			+51	+71	+91	+124	+146	+178	+214	+258	+335	+445	+585
-9	-15		+3	0	+13	+23	+37			+54	+79	+104	+144	+172	+210	+254	+310	+400	+525	+690
-11	-18		+3	0	+15	+27	+43			+63	+92	+122	+170	+202	+248	+300	+365	+470	+620	+800
-11	-18		+3	0	+15	+27	+43			+65	+100	+134	+190	+228	+280	+340	+415	+535	+700	+900
-11	-18		+3	0	+15	+27	+43			+68	+108	+146	+210	+252	+310	+380	+465	+600	+780	+1000
-13	-21		+4	0	+17	+31	+50			+77	+122	+166	+236	+284	+350	+425	+520	+670	+880	+1150
-13	-21		+4	0	+17	+31	+50			+80	+130	+180	+258	+310	+385	+470	+575	+740	+960	+1250
-13	-21		+4	0	+17	+31	+50			+84	+140	+196	+284	+340	+425	+520	+640	+820	+1050	+1350
-16	-26		+4	0	+20	+34	+56			+94	+158	+218	+315	+385	+475	+580	+710	+920	+1200	+1550
-16	-26		+4	0	+20	+34	+56			+98	+170	+240	+350	+425	+525	+650	+790	+1000	+1300	+1700
-18	-28		+4	0	+21	+37	+62			+108	+190	+268	+390	+475	+590	+730	+900	+1150	+1500	+1900
-18	-28		+4	0	+21	+37	+62			+114	+208	+294	+435	+530	+660	+820	+1000	+1300	+1650	+2100
-20	-32		+5	0	+23	+40	+68			+126	+232	+330	+490	+595	+740	+920	+1100	+1450	+1850	+2400
-20	-32		+5	0	+23	+40	+68			+132	+252	+360	+540	+660	+820	+1000	+1250	+1600	+2100	+2600
			0	0	+26	+44	+78			+150	+280	+400	+600							
			0	0	+26	+44	+78			+155	+310	+450	+660							
			0	0	+30	+50	+88			+175	+340	+500	+740							
			0	0	+30	+50	+88			+185	+380	+560	+840							
			0	0	+34	+56	+100			+210	+430	+620	+940							
			0	0	+34	+56	+100			+220	+470	+680	+1050							
			0	0	+40	+66	+120			+250	+520	+780	+1150							
			0	0	+40	+66	+120			+260	+580	+840	+1300							
			0	0	+48	+78	+140			+300	+640	+960	+1450							
			0	0	+48	+78	+140			+330	+720	+1050	+1600							
			0	0	+58	+92	+170			+370	+820	+1200	+1850							
			0	0	+58	+92	+170			+400	+920	+1350	+2000							
			0	0	+68	+110	+195			+440	+1000	+1500	+2300							
			0	0	+68	+110	+195			+460	+1100	+1650	+2500							
			0	0	+76	+135	+240			+550	+1250	+1900	+2900							
			0	0	+76	+135	+240			+580	+1400	+2100	+3200							

# General technical information

## Fit dimension tolerance

### Basic deviation value

Dimension mm		Basic deviation value																						
		lower deviation EI											upper deviation ES			PtoZC								
		All the standard tolerance grade											IT6	IT7	IT8		≤IT8	>IT8	≤IT8	>IT8	≤IT8	>IT8	≤IT7	
Greater than	To	A	B	C	CD	D	E	EF	F	FG	G	H	JS	J	K	M	N							
---	3	+270	+140	+60	+34	+20	+14	+10	+6	+4	+2	0		+2	+4	+6	0	0	-2	-2	-4	-4		
3	6	+270	+140	+70	+46	+30	+20	+14	+10	+6	+4	0		+5	+6	+10	-1+Δ		-4+Δ	-4	-8+Δ	0		
6	10	+280	+150	+80	+56	+40	+25	+18	+13	+8	+5	0		+5	+8	+12	-1+Δ		-6+Δ	-6	-10+Δ	0		
10	14	+290	+150	+95		+50	+32		+16		+6	0		+6	+10	+15	-1+Δ		-7+Δ	-7	-12+Δ	0		
14	18																							
18	24	+300	+160	+110		+65	+40		+20		+7	0		+8	+12	+20	-2+Δ		-8+Δ	-8	-15+Δ	0		
24	30																							
30	40	+310	+170	+120		+80	+50		+25		+9	0		+10	+14	+24	-2+Δ		-9+Δ	-9	-17+Δ	0		
40	50	+320	+180	+130		+80	+50		+25		+9	0		+10	+14	+24	-2+Δ		-9+Δ	-9	-17+Δ	0		
50	65	+340	+190	+140		+100	+60		+30		+10	0		+13	+18	+28	-2+Δ		-11+Δ	-11	-20+Δ	0		
65	80	+360	+200	+150		+100	+60		+30		+10	0		+13	+18	+28	-2+Δ		-11+Δ	-11	-20+Δ	0		
80	100	+380	+220	+170		+120	+72		+36		+12	0		+16	+22	+34	-3+Δ		-13+Δ	-13	-23+Δ	0		
100	120	+410	+240	+180		+120	+72		+36		+12	0		+16	+22	+34	-3+Δ		-13+Δ	-13	-23+Δ	0		
120	140	+460	+260	+200		+145	+85		+43		+14	0		+18	+26	+41	-3+Δ		-15+Δ	-15	-27+Δ	0		
140	160	+520	+280	+210		+145	+85		+43		+14	0		+18	+26	+41	-3+Δ		-15+Δ	-15	-27+Δ	0		
160	180	+580	+310	+230		+170	+100		+50		+15	0		+22	+30	+47	-4+Δ		-17+Δ	-17	-31+Δ	0		
180	200	+660	+340	+240		+170	+100		+50		+15	0		+22	+30	+47	-4+Δ		-17+Δ	-17	-31+Δ	0		
200	225	+740	+380	+260		+190	+110		+56		+17	0		+25	+36	+55	-4+Δ		-20+Δ	-20	-34+Δ	0		
225	260	+820	+420	+280		+190	+110		+56		+17	0		+25	+36	+55	-4+Δ		-20+Δ	-20	-34+Δ	0		
260	280	+920	+480	+300		+210	+125		+62		+18	0		+29	+39	+60	-4+Δ		-21+Δ	-21	-37+Δ	0		
280	315	+1050	+540	+330		+210	+125		+62		+18	0		+29	+39	+60	-4+Δ		-21+Δ	-21	-37+Δ	0		
315	355	+1200	+600	+360		+230	+135		+68		+20	0		+33	+43	+66	-5+Δ		-23+Δ	-23	-40+Δ	0		
355	400	+1350	+680	+400		+230	+135		+68		+20	0		+33	+43	+66	-5+Δ		-23+Δ	-23	-40+Δ	0		
400	450	+1500	+760	+440		+260	+145		+76		+22	0							-26		-44			
450	500	+1650	+840	+480		+260	+145		+76		+22	0							-26		-44			
500	560					+290	+160		+80		+24	0							-30		-50			
560	630					+290	+160		+80		+24	0							-30		-50			
630	710					+320	+170		+86		+26	0							-34		-56			
710	800					+320	+170		+86		+26	0							-34		-56			
800	900					+350	+195		+98		+28	0							-40		-66			
900	1000					+350	+195		+98		+28	0							-40		-66			
1000	1120					+390	+220		+110		+30	0							-48		-78			
1120	1250					+390	+220		+110		+30	0							-48		-78			
1250	1400					+430	+240		+120		+32	0							-58		-92			
1400	1600					+430	+240		+120		+32	0							-58		-92			
1600	1800					+480	+260		+130		+34	0							-68		-110			
1800	2000					+480	+260		+130		+34	0							-68		-110			
2000	2240					+520	+290		+145		+38	0							-76		-135			
2240	2500					+520	+290		+145		+38	0							-76		-135			
2500	2800																							
2800	3150																							

Deviation = ± ITn/2, and ITn is the number of IT

More than IT7 corresponding numerical increase a Δ value

- Note: 1. The basic size less than or equal to 1 mm, basic deviation of A and B and is greater than IT8, N are not used  
 2. If tolerance zone js7 to js11, ITn number values is odd, the deviation = ±(ITn-1)/2  
 3. For less than or equal to IT8 K, M, N and less than or equal to IT7 P to ZC, required Δ values from a table in the right selection  
 For example: 18<sup>h</sup>30mm, K7: Δ=8 μm, so ES=-2+8=+6 μm  
 18<sup>h</sup>30mm, S6: Δ=4 μm, so ES=-35+4=-31 μm  
 4. Special cases: 250 ~ 315 mm segment of the M5, ES= -9 μm (instead of -11 μm).

# General technical information

## Fit dimension tolerance

μm

Basic deviation value												The number of Δ						
upper deviation ES												standard tolerance grade						
Standard tolerance grade more than IT7												standard tolerance grade						
P	R	S	T	U	V	X	Y	Z	ZA	ZB	ZC	IT3	IT4	IT5	IT6	IT7	IT8	
-6	-10	-14		-18		-20		-26	-32	-40	-60	0	0	0	0	0	0	
-12	-15	-19		-23		-28		-35	-42	-50	-80	1	1.5	1	3	4	6	
-15	-19	-23		-28		-34		-42	-52	-67	-97	1	1.5	2	3	6	7	
-18	-23	-28		-33		-40		-50	-64	-90	-130	1	2	3	3	7	9	
					-39	-45		-60	-77	-108	-150							
-22	-28	-35		-41	-47	-54	-63	-73	-98	-136	-188	1.5	2	3	4	8	12	
			-41	-48	-55	-64	-75	-88	-118	-160	-218							
-26	-34	-43		-48	-60	-68	-80	-94	-112	-148	-200	-274	1.5	3	4	5	9	14
			-54	-70	-81	-97	-114	-136	-180	-242	-325							
-32	-41	-53	-66	-87	-102	-122	-144	-172	-226	-300	-405	2	3	5	6	11	16	
	-43	-59	-75	-102	-120	-146	-174	-210	-274	-360	-480							
-37	-51	-71	-91	-124	-146	-178	-214	-258	-335	-445	-585	2	4	5	7	13	19	
	-54	-79	-104	-144	-172	-210	-254	-310	-400	-525	-690							
-43	-63	-92	-122	-170	-202	-248	-300	-365	-470	-620	-800	3	4	6	7	15	23	
	-65	-100	-134	-190	-228	-280	-340	-415	-535	-700	-900							
	-68	-108	-146	-210	-252	-310	-380	-465	-600	-780	-1000							
-50	-77	-122	-166	-236	-284	-350	-425	-520	-670	-880	-1150	3	4	6	9	17	26	
	-80	-130	-180	-258	-310	-385	-470	-575	-740	-960	-1250							
	-84	-140	-196	-284	-340	-425	-520	-640	-820	-1050	-1350							
-56	-94	-158	-218	-315	-385	-475	-580	-710	-920	-1200	-1550	4	4	7	9	20	29	
	-98	-170	-240	-350	-425	-525	-650	-790	-1000	-1300	-1700							
-62	-108	-190	-268	-390	-475	-590	-730	-900	-1150	-1500	-1900	4	5	7	11	21	32	
	-114	-208	-294	-435	-530	-660	-820	-1000	-1300	-1650	-2100							
-68	-126	-232	-330	-490	-595	-740	-920	-1100	-1450	-1850	-2400	5	5	7	13	23	34	
	-132	-252	-360	-540	-660	-820	-1000	-1250	-1600	-2100	-2600							
-78	-150	-280	-400	-600														
	-155	-310	-450	-660														
-88	-175	-340	-500	-740														
	-185	-380	-560	-840														
100	-210	-430	-620	-940														
	-220	-470	-680	-1050														
-120	-250	-520	-780	-1150														
	-260	-580	-840	-1300														
-140	-300	-640	-960	-1450														
	-330	-720	-1050	-1600														
-170	-370	-820	-1200	-1850														
	-400	-920	-1350	-2000														
-195	-440	-1000	-1500	-2300														
	-460	-1100	-1650	-2500														
-240	-550	-1250	-1900	-2900														
	-580	-1400	-2100	-3200														

# General technical information

## Hardness comparison table

Hardness comparison table (Black metal hardness and strength of approximate conversion value)

Hardness				Tensile Strength N/mm <sup>2</sup>	Hardness				Tensile Strength N/mm <sup>2</sup>
Rockwell		Vickers	Brinell		Rockwell		Vickers	Brinell	
HRC	HRA	HV	HB		HRC	HRA	HV	HB	
70.0	86.6	1037	—	—	—	—	—	—	
69.5	86.3	1017	—	—	—	—	—	—	
69.0	86.1	997	—	—	—	—	—	—	
68.5	85.8	978	—	—	—	—	—	—	
68.0	85.5	959	—	—	—	—	—	—	
67.5	85.2	941	—	—	—	—	—	—	
67.0	85.0	923	—	—	—	—	—	—	
66.5	84.7	906	—	—	—	—	—	—	
66.0	84.4	889	—	—	—	—	—	—	
65.5	84.1	872	—	—	—	—	—	—	
65.0	83.9	856	—	—	—	—	—	—	
64.5	83.6	840	—	—	—	—	—	—	
64.0	83.3	825	—	—	—	—	—	—	
63.5	83.1	810	—	—	—	—	—	—	
63.0	82.8	795	—	—	—	—	—	—	
62.5	82.5	780	—	—	—	—	—	—	
62.0	82.2	766	—	—	—	—	—	—	
61.5	82.0	752	—	—	—	—	—	—	
61.0	81.7	739	—	—	—	—	—	—	
60.5	81.4	726	—	—	—	—	—	—	
60.0	81.2	713	—	—	—	—	—	2555	
59.5	80.9	700	—	—	—	—	—	2500	
59.0	80.6	688	—	—	—	—	—	2450	
58.5	80.3	676	—	—	—	—	—	2395	
58.0	80.1	664	—	—	—	—	—	2345	
57.5	79.8	653	—	—	—	—	—	2295	
57.0	79.5	642	—	—	—	—	—	2250	
56.5	79.3	631	—	—	—	—	—	2205	
56.0	79.0	620	—	—	—	—	—	2160	
55.5	78.7	609	—	—	—	—	—	2115	
55.0	78.5	599	—	—	—	—	—	2075	
54.5	78.2	589	—	—	—	—	—	2035	
54.0	77.9	579	—	—	—	—	—	1995	
53.5	77.7	570	—	—	—	—	—	1955	
53.0	77.4	561	—	—	—	—	—	1920	
52.5	77.1	551	—	—	—	—	—	1885	
52.0	76.9	543	—	—	—	—	—	1850	
51.5	76.6	534	—	—	—	—	—	1815	
51.0	76.3	525	—	—	—	—	—	1780	
50.5	76.1	517	—	—	—	—	—	1750	
50.0	75.8	509	—	—	—	—	—	1720	
49.5	75.5	501	—	—	—	—	—	1690	
49.0	75.3	493	—	—	—	—	—	1660	
48.5	75.0	485	—	—	—	—	—	1630	
48.0	74.7	478	—	—	—	—	—	1605	
47.5	74.5	470	—	—	—	—	—	1575	
47.0	74.2	463	—	—	—	—	—	1550	
46.5	73.9	456	—	—	—	—	—	1525	
46.0	73.7	449	—	—	—	—	—	1500	
45.5	73.4	443	—	—	—	—	—	1475	
45.0	73.2	436	—	—	—	—	—	1450	
44.5	72.9	429	—	—	—	—	—	1430	
44.0	72.6	423	—	—	—	—	—	1405	
43.5	72.4	417	—	—	—	—	—	1385	
43.0	72.1	411	—	—	—	—	—	1360	
42.5	71.8	405	—	—	—	—	—	1340	
42.0	71.6	399	—	—	—	—	—	1320	
41.5	71.3	393	—	—	—	—	—	1300	
41.0	71.1	388	—	—	—	—	—	1280	
40.0	70.8	382	—	—	—	—	—	1260	
40.0	70.5	377	—	—	—	—	—	1245	
39.5	70.3	372	—	—	—	—	—	1225	
39.0	70.0	367	—	—	—	—	—	1210	
38.5	—	362	—	—	—	—	—	1190	
38.0	—	357	—	—	—	—	—	1175	
37.5	—	352	—	—	—	—	—	1160	
37.0	—	347	—	—	—	—	—	1140	
36.5	—	342	—	—	—	—	—	1125	
36.0	—	338	—	—	—	—	—	1110	
35.5	—	333	—	—	—	—	—	1095	
35.0	—	329	—	—	—	—	—	1080	
34.5	—	324	—	—	—	—	—	1065	
34.0	—	320	—	—	—	—	—	1050	
33.5	—	316	—	—	—	—	—	1035	
33.0	—	312	—	—	—	—	—	1020	
32.5	—	308	—	—	—	—	—	1010	

# General technical information

## Hardness comparison table

Hardness				Tensile Strength N/mm <sup>2</sup>	Hardness				Tensile Strength N/mm <sup>2</sup>
Rockwell		Vickers	Brinell		Rockwell		Vickers	Brinell	
HRC	HRA	HV	HB		HRC	HRA	HV	HB	
32.0	—	304	298	995	24.0	—	249	245	820
31.5	—	300	294	980	23.5	—	246	242	810
31.0	—	296	291	970	23.0	—	243	240	800
30.5	—	292	287	960	22.5	—	240	237	790
30.0	—	289	283	950	22.0	—	237	234	785
29.5	—	285	280	935	21.5	—	234	232	775
29.0	—	281	276	920	21.0	—	231	229	765
28.5	—	278	273	910	20.5	—	229	227	760
28.0	—	274	269	900	20.0	—	226	225	750
27.5	—	271	266	890	19.5	—	223	222	745
27.0	—	268	263	880	19.0	—	221	220	735
26.5	—	264	260	870	18.5	—	218	218	730
26.0	—	261	257	860	18.0	—	216	216	725
25.5	—	258	254	850	17.5	—	214	214	715
25.0	—	255	251	835	17.0	—	211	211	710
24.5	—	252	248	830					

Note: this table listed all the equivalent value of steel tie, applicable to steel from low to high carbon content  
 Tensile strength values listed in this table, suitable for general steel grade of conversion accuracy is not high, 1N/mm<sup>2</sup>=1Mpa.  
 This table from GB1172-74.



# General technical information

The world tool grade comparison table

# General technical information

The world tool grade comparison table

## CVD coated grade

Design	Material Code	JTCC	SANDVIK	KENNAMETAL	SECO	ISCAR	MITSUBISHI	SUMITOMO	TUNMALOY	KYOCERA	DIJET	ZCCT	
P	P01		GC4005	KC9110 IN7005	TP1000		UE6005	AC700G	T9005	CR7015	JC110V		
	P10	JT4015 JT4115	GC4005 GC4015 GC3115	KC9110 IN7005 IN7010	TP1000 TP2000 TP200 TX150	IC9015	UE6005 UE6010 UE6020 UC6010	AC700G AC2000	T9015	CA5515 CR7015	JC110V JC215V	YBC151	
		JT4025 JT4125	GC4015 GC4025 GC2015 GC3025	KC9125 IN7015	TP2000 TP200	IC9025	UE6010 UE6020 UC6010	AC2000	T9015 T9025	CA5515 CA5525 CA5025 CR9025	JC110V JC215V	YBC251	
	P30	JT4035 JT4135	GC4025 GC4035 GC2025 GC2135	KC8050 KC850 IN7025	TP3000 TP300 TP400	IC656 IC9064	UE6035 UH6400 US735	AC3000	T9025 T9035	CA5525 CA5025 CA9025	JC215V JC325V	YBC351	
JT4135		GC4035 GC235	KC9040	TP400 TP40	IC9054 IC635	UE6035 UH6400 US735	AC3000	T9035		JC325V JC450V	YBC351 YB235		
M	M10	JT4330	GC2015	IN7010	TP200		US7020	AC2000	T9015	CA6015	JC110V	YBM151	
	M20	JT4340	GC2025	KC9225 IN7015 IN7525	TP200 TP300	IC9025	US7020	AC2000	T6020	CA6015	JC110V	YBM251	
M30	JT4350	GC2135 GC235	KC9040 KC8050 IN7025 IN8025	TP300 TP400 TP40	IC9025	US735	AC3000 AC304	T6030				YB235	
M40	JT4350	GC235	KC9240 KC9245	TP400 TP40		US735	AC304					YB235	
K	K01	JT3105	GC3205 GC3210		TX100	IC9007	UC5105 UC5005	AC300G	T5010	CA4010	JC105V	YB052 YB0102	
	K10	JT3105 JT3115	GC3005 GC3015 GC3115 GC3205 GC3210	KC9315 IN5015 IN7010	TX100 TX150	IC418 IC428	UC5115 UC5015 UE6010 UC6010	AC700G	T5010 T5020		CA4010 CA4115	JC105V JC110V	YB0102 YB0151 YB0152
K20	JT3125 JT3115	GC3215 GC3025	KC9325 IN5020 IN7015	TP200 TX150	IC9015	UE6010 UC6010	AC700G	T5020		CA4120	JC100V JC215V	YB0252	
K30	JT3125 JT3135		KC8050 KC9040 IN7025	TP200							JC215V	YB0252	

## CVD coated grade

Design	Material Code	JTCC	SANDVIK	KENNAMETAL	SECO	ISCAR	MITSUBISHI	SUMITOMO	TUNMALOY	KYOCERA	DIJET	ZCCT	
P	P10				T200M T250M								
	P20	JT4330	GC4020		T200M T250M T350M T25M	IC520M	F7030				JC730U	YBC201 YBM251	
		JT4330 JT4340	GC4030	KC930M	T250M T350M T25M	IC4050 IC450	F7030	AC230	T3030				YBC301
	P40	JT4340 JT4350	GC4030		T350M	IC4050 IC635						YBC401 YBM351 YB235	
M	M10												
	M20	JT4330		KC925M	T250M T25M		F7030				JC730U	YB235	
		JT4340 JT4350	GC2040	KC930M	T350M T25M		F7030		T3030				YBM351 YBC401
	M40	JT4350											
K	K01												
	K10			KC915M		T150M T200M	IC4010 IC418	F5010	AC211	T1015		JC600	
K20			KC925M	GC3020		IC520M	F5020		T1020		JC610		
K30			KC930M	GC3040	T200M	IC4050 IC450						YBG40	

# General technical information

The world tool grade comparison table

## PVD coated grade

Group	Material Code	JTCC	SANDVIK	KENAMETAL	SECO	ISCAR	MITSUBISHI	SUMITOMO	TUNMALOY	KYOCERA	DIJET	ZCCT
P	P01									PR951	JC5003	
	P10	JT1015		KC5010 KC5510	CP200	IC507	VP10MF			PR630PR915PR930	JC5003	YBG102
	P20	JT1025	GC1020GC4125 GC1025		CP250	IC507IC570 IC308IC908	VP15TF VP20MF			PR630 PR930	JC5015	YBG202 YBM252 YBG201
	P30	JT1035			CP500	IC308IC908 IC328IC3028 IC354	VP15TF VP20MF			PR660	JC5015	YBG302
M	P40		GC1020 GC2145		CP500	IC328IC3028 IC354						
	M01							EH51Z				
	M10	JT1015		KC5010KC5510	CP200	IC507IC907	VP10MF	EH51Z		PR630PR915	JC5003	YBG102
	M20	JT1025 JT1125	GC1020GC1025 GC4125		CP200 CP500	IC507IC908 IC1028	VP15TF VP20MF	EH52Z	GH330	PR630 PR915	JC5015	YBG202 YBM252 YBG201
K	M30	JT1035		KC5025 KC5525 KC710	CP500	IC328IC3028 IC1028	VP15TF VP20MF		AH120	PR660	JC5015	YBG302
	M40		GC2145			IC328 IC3028						
	K01							EH10Z	AH110		JC5003	
	K10	JT1015		KC5010KC5510	CP200	IC507IC907		EH10Z/EH20Z	GH110AH110		JC5003JC5015	YBG102
S	K20	JT1025 JT1125	GC1020		CP200CP250	IC308IC908	VP15TF	EH20Z	AH120		JC5015	YBG202 YBM252 YBG201
	K30	JT1035	GC4125		CP500	IC328IC3028 IC1028	VP15TF					
	S01						VP05RT		AH110		JC5003	
	S10		GC1005 GC1025	KC5410KC5014KC5510	CP200CP250 CP500		VP05RT VP10RT	EH51Z	AH120		JC5015	YBG102 YBG202
S	S20		GC4125	KC5025 KC5525	CP250 CP500		VP10RT VP15TF	EH20Z EH520Z				YBG202
	S30						VP15TF					

# General technical information

The world tool grade comparison table

## PVD coated grade

Group	Material Code	JTCC	SANDVIK	KENAMETAL	SECO	ISCAR	MITSUBISHI	SUMITOMO	TUNMALOY	KYOCERA	DIJET	ZCCT
P	P01										JC5003	
	P10	JT1015 JT1025		KC792M KC715M				ACZ310		PR630PR730PR830	JC5003 JC5030	YBG102
	P20	JT1025 JT1035	GC1025	KC522M KC525M	F25M	IC950 IC908	VP15TF	ACZ310 ACZ330		PR630PR730PR830 JC5015JC5030JC5040	JC5003 JC5030	YBG202 YBM252
	P30	JT1035 JT1025		KC725M	F25M F30M	IC250	VP15TF VP30RT	ACZ330 ACZ350	GH330AH330 AH120 AH740	PR660	JC5015 JC5040	YBG202 YB302
M	P40	JT1035		KC735M	F40M T60M	IC328 IC928	VP30RT	ACZ350	AH120		JC5040	YBG302 YBG402
	M01											
	M10			KC715M						PR630PR730PR830	JC5003	
	M20	JT1025	GC1025	KC522M KC525M	F25M	IC908	VP15TF	ACZ310	GH330	PR630PR730PR830 JC5015JC5030JC5040	JC5003	YBG202 YBM252
M	M30	JT1035	GC2030	KC725M KC735M	F30M F40M	IC928	VP15TF VP30RT	ACZ330 ACZ350	AH120	PR660	JC5015JC5030JC5040	YBG302
	M40	JT1035				IC328	VP30RT	ACZ350	AH140			YBG302 YBG402

# General technical information

The world tool grade comparison table

## PVD coated grade

Group	Code	JTCC	SANDVIK	KENAMETAL	SECO	ISCAR	MITSUBISHI	SUMITOMO	TUNMALOY	KYOCERA	DIJET	ZCCT
K	K01								AH110	PR510	JC5003	
	K10	JT1015		KC510M			ACZ310	AH110 GH110	PR510 PR905	JC5003 JC5015		YBG102 YBG202
	K20	JT1025		KC520M KC522N KC525M		IC910 IC950	VP15TF	AH120	PR905	JC5015		YBG202
	K30	JT1035		KC725M		IC328 IC908 IC928	VP15TF					YBG302
S	S01										JC5003	
	S10	JT1025	GC1025	KC510M		IC908	VP15TF	AH120		JC5015		YBG202
	S20	JT1025		KC522M KC525M		IC908	VP15TF					YBG202
H	S30	JT1035		KC725M	F40M	IC328 IC928					JC5003	YBG302
	H01											
	H10	JT1015 JT1025		F15M			VP15TF				JC5015	YBG102 YBG202
H	H20	JT1025		F15M			VP15TF					YBG202
	H30			F30M								

# General technical information

The world tool grade comparison table

## Hard alloy material

Group	Code	JTCC	SANDVIK	KENAMETAL	SECO	ISCAR	MITSUBISHI	SUMITOMO	泰克洛	KYOCERA	DIJET	ZCCT
P	P01										SRN	
	P10	JP101	SIP	P10		IC70		ST10P ST15E	TX10S		SRT	YC10
	P20	JP201	SMA	K125M TTM		IC70 IC50M	UT120T	ST20E	TX20 TX25		SRT DX30	YC25S
	P30	JP301	SM30	GK K600 TTR		IC50M IC54	UT120T	A30 A30N	TX30 UX30	PW30	SR30 DX30 DX35	YC30S
M	P40	JP401	S6	G13		IC54		ST40E	TX40		SR30 DX35	YC40
	M10		H10A	K313	890			EH510 U10E	TU10		UMN UM10	
	M20		H13A	K68 KMF K125M TTM	HX 883	IC08	UT120T	EH520 U2	TU20		DX25 UM20 UMS	YD201
	M30	JP301	H10F SM30	K600 TTR		IC08 IC28	UT120T	A30 A30N	UX30		DX25 UM30 UMS	YM30 YC30S
K	M40	JP401	S6	G13		IC128			TU40		UM40	YC40
	K01	JK051	H1P	K605		IC128	HT105T	H1 H2	TH03		KG03	YD051
	K10	JK051 JK101	H1P H10HM	KU10 K313 K08	890	IC20	HT110	EH10 EH510	G1F TH10	KW10	KG10 KT9	YD051 YD101 YD15S
	K20	JK101 JK201	H13A	KU10 K313 K08	890 HX 883	IC20 IC10	UT120T	G10E EH520	G2F KS20		KT9 CR1 KG20	YD201
N	K30	JK301			883	IC10 IC28	UT120T	G10E	G3		KG30	
	N01	JK101 JK001	H10 H13A	K605				H1 H2			KG03	YD101 YD201
	N10			KU10 K313 K08	890 H15		HT110	EH10 EH510	TH10 H10T KS05F		KG10 KT9	
	N20			K715 KMF K600	HX KX 883 H15 H25			G10E EH520			CR1 KG20	
S	N30			G13 THR	H25						KG30	
	S01						RT9005				KG03	
	S10	JK001 JK201	H10 H10A H10F H13A	K10 K313 THM	890		RT9005 RT9010	EH10 EH510	TH10		FZ05 KG10	YD101 YM30 YD201
	S20			K715 KMF	890 883 HX H25		RT9010 TF15	EH20 EH520	KS20		FZ15 KG20	
S30			G13 K600 THR			TF15				KG30		

# General technical information

The world tool grade comparison table

## Hard alloy material

Group	Code	JTCC	SANDVIK	KENAMETAL	SECO	ISCAR	MTSUBISHI	SUMITOMO	TUNMALOY	KYOCERA	DIJET	ZCCT
P	P10	JP101	SIP								SRT	YC10
	P20	JP201		K125		IC50M IC28	UTi20T	A30N	TX25		SRT DX30	
	P30	JP301		GX K600		IC50M IC28	UTi20T	A30N	UX30	PW30	SR30 DX30	
	P40	JP401				IC28				PW30	SR30	
M	M10			K110M							UMN	
	M20	JP201		K313			UTi20T	A30N			DX25 UMS	
	M30	JP301		KFM K600		IC28	UTi20T	A30N	UX30		DX25 UMS	
	M40	JP401				IC28			TU40			
K	K01						HTi05T				KG03	
	K10	JK051	HIP	K110M K313		IC20	HTi10	G10E	TH10	KW10	KG10	YD051
	K20	JK201		KFM	HX	IC20 IC10	HTi20T	G10E			KT9 KG20	
	K30	JK301				IC10 IC18	HTi20T				KG30	



远见赢天下

## 江西江钨硬质合金有限公司

JIANGXI JIANGWU CEMENTED CARBIDE CO.,LTD

地址: 江西省靖安县工业园  
Add: JingAn Industrial Zone, Jiangxi, China  
邮编 Post code: 330600  
电话 Tel: 86-795-4652929 4713958  
传真 Fax: 86-795-4668699  
邮箱 E-mail: jxjw@jxjtc.com  
网址 Website: www.jxjtc.com



2015 VERSION

# 硬质合金棒材

CARBIDE RODS



江西江钨硬质合金有限公司

JIANGXI JIANGWU CEMENTED CARBIDE CO.,LTD



## INDUSTRIAL CHAIN

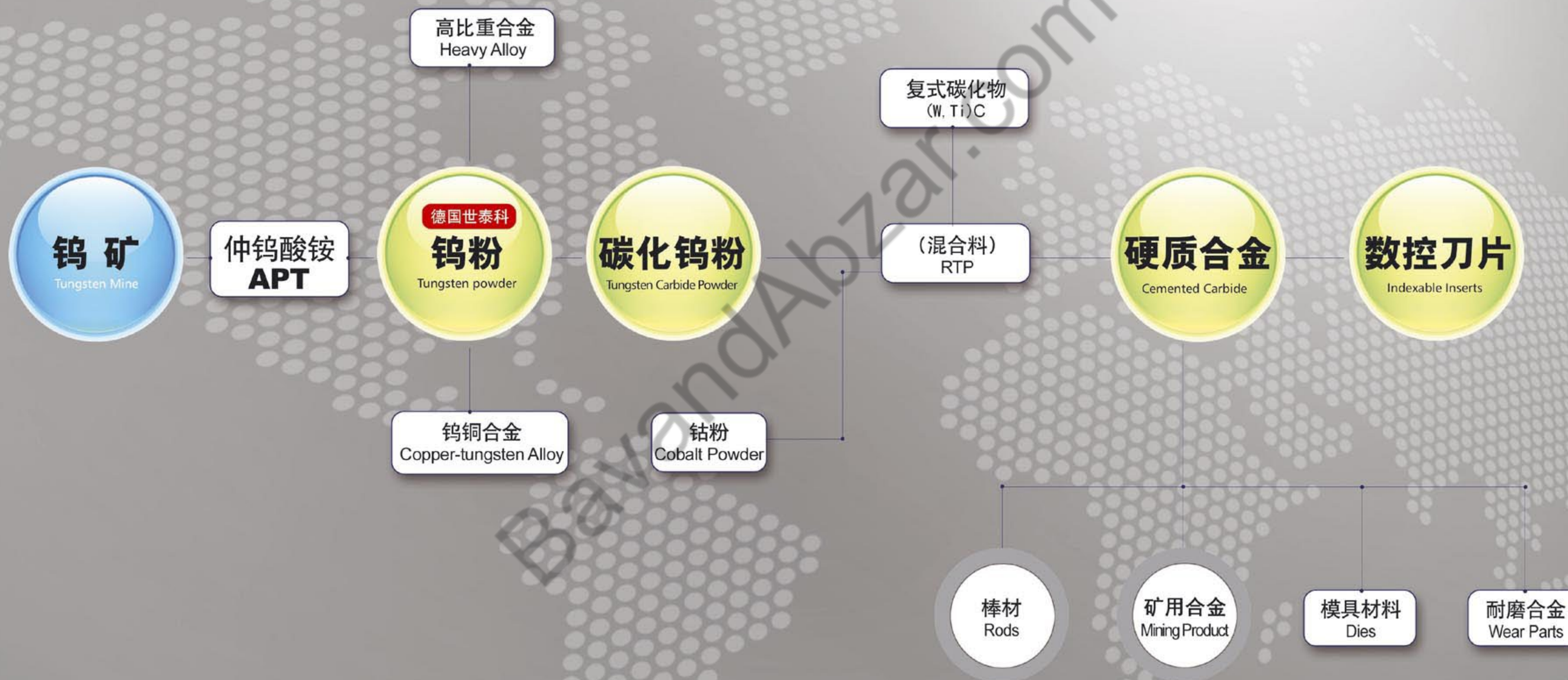



诚信致远·合作共赢  
INTEGRITY TOWIN WIN-WIN COOPERATION

# CONTENTS 目录

公司简介 Company profile	P1-P2
产业链 Industrial chain	P3-P4
目录 Contents	P5
型材产品牌号概览 Grade introduction	P6
硬质合金牌号性能及推荐用途表 Grade performances	P7-P8
材料选择及产品公差 Material choose and tolerance	P9-P10
PCB刀具用棒材牌号性能以及牌号对照参考表 Grade performances for PCB tools and Grade comparison	P11-P12
材质项目名词解释 Definition of physical property	P13-P15
尺寸项目名词 Definition of geometrical tolerance	P16-P17
硬度换算表及公差等级 Hardness change & Tolerance grade	P18-P20
设备展示 Equipments	P21
品质保证 Quality assurance	P22

## 型材产品牌号概览 Grade Introduction

序号 NO.	牌号 Grade	国际分类号 ISO Code	钴含量 Cobalt (%)	硬度 HRA	密度 Density g/cm <sup>3</sup>	强度 TRS N/mm <sup>2</sup>	平均晶粒度 Grain size (μm)
1	JT104U	K05-K10	6.5	94	14.75	3500	0.4
2	JT106U	K05-K10	6.5	94	14.75	3500	0.4
3	JT104F	K05-K10	6.0	93.5	14.83	3500	0.6
4	JT204N	K20-30	9.0	94	14.50	3500	0.2
5	JT302A	K20-30	10.0	91.7	14.45	3500	0.8
6	JT304	K20-30	10.0	91.7	14.45	3700	0.8
7	JT304U	K20-30	10.0	93.5	14.45	3500	0.4
8	JT401	K30-40	12.0	92.3	14.15	3800	0.6
9	JT403	K30-40	12.0	92.5	14.15	3800	0.4
10	JT404	K30-40	12.0	92.3	14.15	4000	0.6
11	JT504U	K30-40	13.0	92.7	14.00	3600	0.4

备注：1.以上数据均为典型值 2.可根据客户的需求定制产品牌号

Note:1. The above data are typical values.2. Customized product grade according to customer demand.



**棒材用硬质合金牌号、性能及推荐用途表**  
**Grade performances**

牌号 Grade	物理机械性能 Physical & mechanical properties				推荐用途 Applications recommended	金相结构 Metallographical structure
	晶粒度 μm	密度 Densiy g/cm³	硬度 HRA	抗弯强度 TRS ≥N/mm²		
<b>NEW!</b> JT104U	0.4	14.65-14.85	93.5-94.5	3500	在JT106U牌号基础上,采用德国优质原料,产品组织结构缺陷少、分布更均匀,整体性能及其寿命更加显著,市场发挥潜力大。 Based on JT106U grade,uses the German high quality raw materials, product structure less defects, more uniform distribution, the overall performance and its life span is more significant, greatmarket potential.	
JT106U	0.4	14.65-14.85	93.5-94.5	3500	适用于加工镁铝合金、玻璃纤维、碳纤维、木材及硬塑料等材料。 Suitable for processing magnesium alloy, glass fiber, carbon fiber, wood, hard plastic materials, etc.	
<b>NEW!</b> JT104F	0.6	14.75-14.91	93.0-94.0	3500	适用于加工各种铝合金等塑性高的材料。 Suitable for processing all kinds of high plastic materials such as aluminum alloy.	
<b>NEW!</b> JT204N	0.2	14.40-14.60	93.0-94.0	3500	适用于加工HRC60高硬钢等材料。 Suitable for above HRC 60 and high hardness material machining.	
JT302A	0.8	14.35-14.55	91.5-92.0	3500	适用于各种碳钢、铸铁、不锈钢、耐热钢、镍基及钛合金等材料的加工。 Suitable for all kinds of carbon steel, cast iron, stainless steel, heat-resistant steel, nickel base and titanium alloy and other materials processing.	

牌号 Grade	物理机械性能 Physical & mechanical properties				推荐用途 Applications recommended	金相结构 Metallographical structure
	晶粒度 μm	密度 Densiyg/cm³	硬度 HRA	抗弯强度 TRS≥N/mm²		
<b>NEW!</b> JT304	0.8	14.35-14.55	91.5-92.0	3700	在JT302A牌号基础上,粉末采用更优质原料,使产品获得更好的综合性能,显著提升产品加工性能和使用寿命,使其更具市场竞争力。 Based on JT302A grade,powder using more high-quality raw materials,makes products to get a better comprehensive performance, significantly improve product performance and service life and make it more market competitiveness.	
<b>NEW!</b> JT304U	0.5	14.30-14.50	92.5-93.5	3500	适用于各种高硬钢等高硬材料的加工。 Suitable for processing all kinds of hard materials such as high hard steel.	
JT401	0.6	14.05-14.25	92.0-92.7	3800	适用于镍基合金、钛合金、不锈钢、模具钢、淬硬钢及灰口铸铁等材料的加工。 Suitable for nickel base alloy, titanium alloy, stainless steel, die steel, hardened steel and grey cast iron and other materials processing.	
JT403	0.4	14.05-14.25	92.2-93	3800	在JT401牌号的基础上采用更细的粉末,使产品获得更好的耐磨性,提高产品的加工性能和使用寿命。推荐用于各种铣刀、钻头、铰刀、适用于高速加工。 Based on JT401, take ultra grain size to get a better wear resistance and life. Recommended for making endmills, drills, good at high speed machining.	
<b>NEW!</b> JT404	0.6	14.05-14.25	92.0-92.7	4000	粉末采用更优质原料,产品使用寿命和抗折力均有极大提升,整体加工效果显著提高,适于高硬加工。 Powder using more high-quality raw materials, the service life of the product and resistance to bending force are greatly improve, the overall processing effect is significantly improved, suitable for high hard machining.	
<b>NEW!</b> JT504U	0.5	13.90-14.10	92.3-93.0	3600	适用于加工各种不锈钢等材料。 Suitable for processing various materials such as stainless steel.	



## 材料选择及产品公差 Material choose and tolerance

### 材料选择 Material Choose

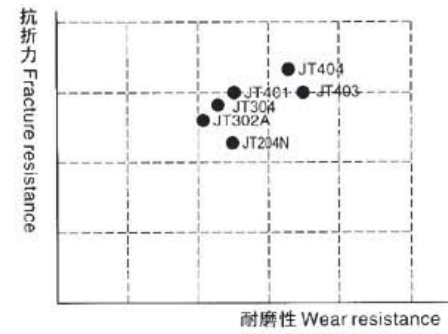
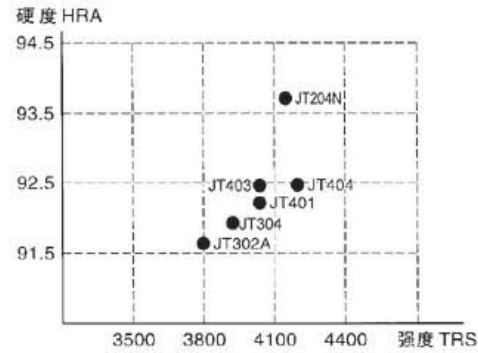

### 标准产品公差 Standard Tolerance

型号表示:  $\Phi \times L$

Type specifications:  $\Phi \times L$

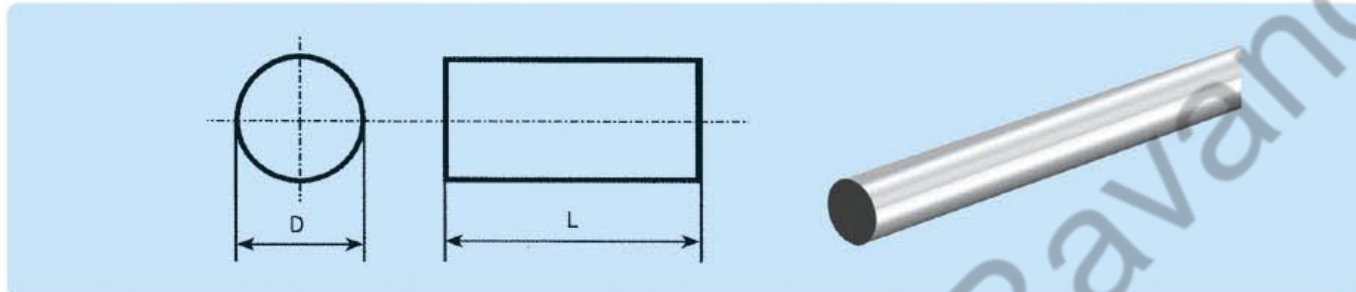

#### (公制) The metric system

型号 Type	外径公差 Tolerance of diameter(mm)	长度公差 Tolerance of length(mm)
$\Phi 1.0 \times 330$	+0.15/+0.30	-0/+5.0
$\Phi 2.0 \times 330$	+0.15/+0.30	-0/+5.0
$\Phi 3.0 \times 330$	+0.15/+0.30	-0/+5.0
$\Phi 4.0 \times 330$	+0.30/+0.50	-0/+5.0
$\Phi 5.0 \times 330$	+0.30/+0.50	-0/+5.0
$\Phi 6.0 \times 330$	+0.30/+0.50	-0/+5.0
$\Phi 7.0 \times 330$	+0.30/+0.60	-0/+5.0

续表1 Table 1

型号 Type	外径公差 Tolerance of diameter(mm)	长度公差 Tolerance of length(mm)
$\Phi 8.0 \times 330$	+0.30/+0.60	-0/+5.0
$\Phi 9.0 \times 330$	+0.30/+0.60	-0/+5.0
$\Phi 10.0 \times 330$	+0.30/+0.60	-0/+5.0
$\Phi 11.0 \times 330$	+0.30/+0.60	-0/+5.0
$\Phi 12.0 \times 330$	+0.30/+0.60	-0/+5.0
$\Phi 13.0 \times 330$	+0.30/+0.70	-0/+5.0
$\Phi 14.0 \times 330$	+0.30/+0.70	-0/+5.0
$\Phi 15.0 \times 330$	+0.30/+0.70	-0/+5.0
$\Phi 16.0 \times 330$	+0.30/+0.70	-0/+5.0
$\Phi 17.0 \times 330$	+0.30/+0.80	-0/+5.0
$\Phi 18.0 \times 330$	+0.30/+0.80	-0/+5.0
$\Phi 19.0 \times 330$	+0.30/+0.80	-0/+5.0
$\Phi 20.0 \times 330$	+0.30/+0.80	-0/+5.0
$\Phi 21.0 \times 330$	+0.30/+0.80	-0/+5.0
$\Phi 22.0 \times 330$	+0.30/+0.80	-0/+5.0
$\Phi 23.0 \times 330$	+0.30/+0.80	-0/+5.0
$\Phi 24.0 \times 330$	+0.30/+0.80	-0/+5.0
$\Phi 25.0 \times 330$	+0.30/+0.80	-0/+5.0
$\Phi 26.0 \times 330$	+0.30/+0.80	-0/+5.0
$\Phi 27.0 \times 330$	+0.30/+0.80	-0/+5.0
$\Phi 28.0 \times 330$	+0.30/+0.80	-0/+5.0
$\Phi 29.0 \times 330$	+0.30/+0.80	-0/+5.0
$\Phi 30.0 \times 330$	+0.30/+0.80	-0/+5.0

#### (英制) The british system

型号 Type	外径公差 Tolerance of diameter(mm)	长度公差 Tolerance of length(mm)
$\Phi 1/8 \times 13$	+0.006/+0.018	-0/+0.197
$\Phi 5/32 \times 13$	+0.006/+0.018	-0/+0.197
$\Phi 3/16 \times 13$	+0.006/+0.018	-0/+0.197
$\Phi 1/4 \times 13$	+0.006/+0.018	-0/+0.197
$\Phi 3/8 \times 13$	+0.006/+0.018	-0/+0.197
$\Phi 1/2 \times 13$	+0.006/+0.018	-0/+0.197
$\Phi 5/16 \times 13$	+0.006/+0.018	-0/+0.197

可按客户要求提供外径 $D \leq 45\text{mm}$ , 长度 $L \leq 700\text{mm}$ 的毛坯棒材  
Rod blanks of  $D \leq 45\text{mm}$ ,  $L \leq 700\text{mm}$  can be supplied at customers' requests.

## 公差标准 Standard Tolerance

毛坯棒 Unground

尺寸 Size(mm)	公差 Tol(mm)
$\phi \leq 5.0$	+0.20~+0.45
$\phi > 5.0$	+0.20~+0.50

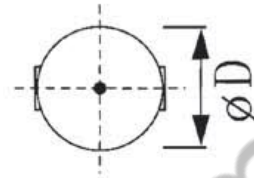

粗磨棒 Rough grounded

尺寸 Size(mm)	公差 Tol(mm)
$\phi \leq 5.0$	+0.00~+0.05
$\phi > 5.0$	+0.00~+0.10

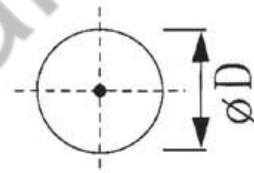

## 牌号对照参考表 Grade Comparison

江西江钨	株洲硬质合金	南昌硬质合金	自贡长城	厦门金鹭	春保硬质合金	日本住友
JXTC	ZCCCT	NCC	Great Wall	GESAC	CB Carbide	SUMITOMO
JT106U	YU06R	TSF10	ZK10UF	GU10UF	K6UF	AF505
JT104U	YU06A			GU10UF		
JT104F	YF06			GU10F	WF03	AF505
JT204N			ZK10SF			AF308
JT302A		YK15			WF15	
JT304	YL10.2		ZK30UF	GU20	K200	AF510
JT401	XF30	YK25	ZK40SF		WF25	
JT403	XF30	YK25		GU25UF		
JT404				GU25UF	TF25+	AF312
JT504U						AF312

备注：牌号对照均为相近或类似，仅供参考，不具法律效力

Note: Grades comparison is similar, for reference only, do not have legal effect.



## 材质项目名词解释

### Definition of Physical Property

#### ◎硬度

Hardness

金属材料抵抗其它更硬物体压入表面的能力称为硬度，主要采用洛氏或维氏硬度测量法，两种硬度值转换时需要注意换算。

The hardness of material is defined as the ability to fight against the hard pressed into surface of the object, mainly using measurements of Rockwell and Vickers. As the principles of the Vickers and Rockwell tests are different, care must be taken when converting from one system to the other.

#### ◎矫顽磁力

Coercive force

矫顽磁力测量的是合金试样完全去磁化所需的反向磁场大小，它可用来评定合金的组织状况，矫顽磁力随钴含量降低而增大，当钴含量一定时，碳化钨晶粒越细，钴相分散程度越高，矫顽磁力也越大。

Coercive Force is a measure of the residual magnetism in the hysteresis loop when the Cobalt (Co) binder in grade of cemented carbide is magnetized and then demagnetized. It can be used to assess the status of alloy organization. The finer the grain size of the carbide phase the higher will be the coercive force value.

#### ◎磁饱和

Magnetic saturation

磁饱和是最大磁化强度与质量的比值，通过测定硬质合金中具有磁性的钴（Co）粘结相的磁饱和，可以评定合金成份。低磁饱和值表示合金含碳量低，或者含有η相碳化物，高磁饱和值表示存在“游离磷或石墨”。

Magnetic saturation is the ratio of magnetic intensity to quality. Magnetic Saturation measurements on the Cobalt (Co) binder phase in cemented carbide are used by the industry to evaluate its composition. Low Magnetic Saturation values indicate a low carbon level and/or the presence of EtaPhase Carbides. High Magnetic Saturation values indicate the presence of 'free carbon' or Graphite.

#### ◎密度

Density

材料的密度（比重）是材料质量与其体积的比率，使用液体置换法进行测定，硬质合金密度随WC-Co相中钴含量增加而增加。

The density (specific gravity) of a material is the ratio of its mass to its volume. It is measured using a water displacement technique. Cemented carbide density decreases linearly with increasing Cobalt content for the We-Co Grade.

## 材质项目名词解释

### Definition of Physical Property

#### ◎抗弯强度

Transverse rupture stress

抗弯强度是表征材料抵抗弯曲不断裂的能力，即试样跨距中点加载负荷至断裂时，单位面积上所受的力大小。

The Transverse Rupture Stress (TRS) is the ability of material to resist bending, measured at the breaking point of a material in a standard three point bend test.

#### ◎金相

Metallographic

硬质合金烧结钴相粘结后，过量钴可能在某些结构区域中存在，形成“钴池”；而当粘结相不完全粘结，则将形成一些少量残余孔隙，合金中钴池及孔隙率使用金相显微镜检验得到。

Cobalt phase will bond after sintering, excess cobalt may exist in certain area of the structure, forming the cobalt pool; If bonding phase is incompletely adhesive, there will form some residual pores. Cobalt pools and porosity can be detected by using metallographic microscope.

#### ◎孔隙度

Porosity

ISO 4505

硬质合金是使用粉末冶金方法制造的，其中金属粘结相用于将碳化相烧结在一起。因此存在这样的可能：由于不完全的烧结，少量的残余孔隙会存在于产品的金相结构中。材料中存在的孔隙的体积是使用一种标准的比较程序来评价的。后者根据一系列的标准图谱将孔隙尺寸范围和分布分成不同类别。尺寸10微米以下的孔隙称为“A”型孔隙。尺寸10-25微米的孔隙称为“B”型孔隙。更大尺寸的孔隙单独测量和分类。硬质合金中孔隙的存在对机械性能有负面的影响。

ISO 4505

Cemented carbide is manufactured by powder metallurgy and the metal binder phase is used to sinter together the carbide phase. So there exists such a possibility: A small amount of residual pores are present in the microstructure of cemented carbide due to the incomplete sintering. The volume of the pores present in the material is to be evaluated by a standard comparison procedure. The latter divides the scope of dimensions and the distribution of pores into several categories: A pore under 10 microns is called porosity "A" A pore of 10-25 microns is called porosity "B" Pores of bigger dimensions are to be measured and classified separately. The existence of pores in cemented carbide will have adverse effects on its mechanical properties.

## 材质项目名词解释

### Definition of Physical Property

#### 钴池

Cobalt lake

硬质合金是采用金属粉末冶金方法制造的。其中金属粘结相用于将碳化物相烧结在一起。因此存在这样的机会：烧结后结构中某些地方存在过多的钴。这种情况被称为“钴池”。钴池是烧结时钴的不完全分布的结果。这可能是由于烧结温度过低，钴不能充分流动。原始粉末材料成形密度不够，或是在热等静压处理时孔隙被钴填充结果。材料中钴池体积的评价是根据其尺寸和分布采用显微照片比较和/或单个测量。硬质合金中钴池的存在会影响耐磨性和强度。

Cemented carbide is manufactured by powder metallurgy and the metal the binder phase is to sinter together the carbide phase. So there exists such an opportunity: Too much cobalt is present in some places of structure after the sintering process and it is called "cobalt lake". Cobalt lake is caused by the incomplete distribution of cobalt in the sintering process. The reason may be the too low sintering temperature to hinder the sufficient flow of cobalt, the insufficiency of density of the virgin compacted material or the filling of cobalt into the pores in the HIP process. The evaluation of the volume of cobalt lake in the material is made by the comparison of micrographs and/or measurement of one by one based on the sizes and distribution. The presence of cobalt lake in cemented carbide will affect its wear resistance and strength.

#### 自断裂韧性

Fracture toughness KIC

断裂韧性KIC是含有临界尺寸缺陷的试样的强度测量尺度，它反映材料塑性变形和断裂全过程中吸收能量的能力，是强度和塑性的综合表现，使用维氏压痕法测定。

Fracture toughness KIC is the measurement strength of samples containing critical defect. Fracture toughness reflects the ability of material to absorb energy in the process of plastic deformation and fracture. Fracture toughness is the performance of strength and the plasticity, which is measured by Vickers.

#### 总碳含量

The total carbon

碳化钨(WC)中理想碳含量范围是6.05-6.14%，高于6.14%，将导致组分中明显的碳过量，超过化学计量值，形成“游离碳”，少于6.02%，将形成 $\eta$ 相碳化物。

The Ideal amount of Carbon In Tungsten Carbide (WC) is 6.13% by weight. An acceptable range of Carbon is 6.05-6.14%, any amount less than 6.02% will result in visible Carbon deficiency by the formation of the Eta-Phase carbides, any amount greater than 6.14% will result in a visible Carbon excess by the formation of 'free-carbon, graphite in the microstructure.

## 尺寸项目名词

### Definition of Geometrical Tolerances

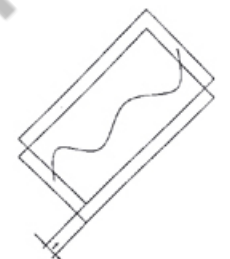
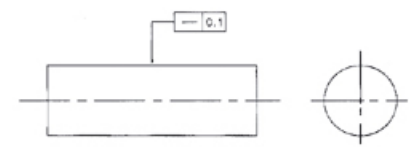
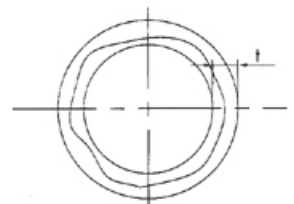
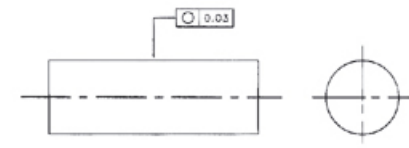
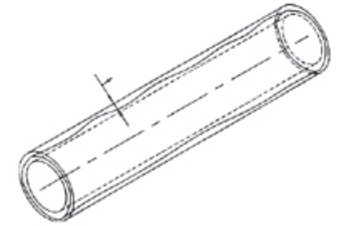
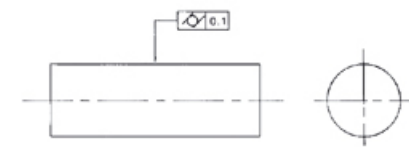
	公差带定义 Definition of Tolerance Zone	标注和解释 Indication and Explanation
直线度 Straightness Tolerance	 <p>在给定方向上公差带是距离公差值t的两平行平面之间的区域。 The tolerance zone, in the considered plane, is limited by two parallel straight lines a distance t apart and in the specified direction only.</p>	 <p>被测圆柱面的任一素线必须位于距离为公差值0.1的两平行平面之内。 Any extracted (actual) line on the upper surface, parallel to the plane of projection in which the indication is shown, shall be contained between two parallel straight lines 0.1 apart.</p>
圆度 Roundness Tolerance	 <p>公差带是在同一正截面上，半径值为公差值t的两同心圆之间的区域。 The tolerance zone, in the considered cross-section, is limited by two concentric circles with a difference in radii of t.</p>	 <p>被测圆柱面任一正截面的圆周必须位于半径差为公差值0.03的两同心圆之间。 The extracted (actual) circumferential line, in any cross-section of the cylindrical and conical surfaces, shall be contained between two co-planar concentric circles, with a difference in radii of 0.03.</p>
圆柱度 Cylindricity	 <p>公差带是半径差为公差值t的两同轴圆柱面之间的区域。 The tolerance zone is limited by two coaxial cylinders with a difference in radii of t.</p>	 <p>公差带是在同一正截面上，半径差为公差值t的两同心圆之间的区域。 The tolerance zone, in the considered cross-section, is limited by two concentric circles with a difference in radii of t.</p>



### 尺寸项目名词

Definition of Geometrical Tolerances

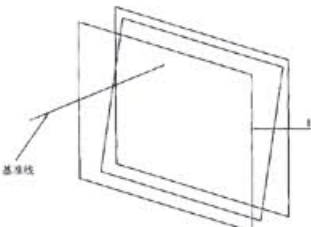
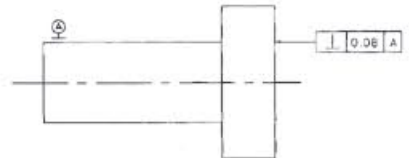
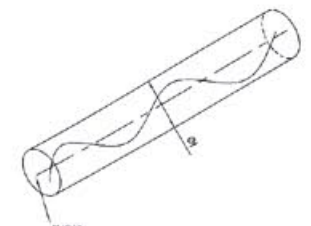
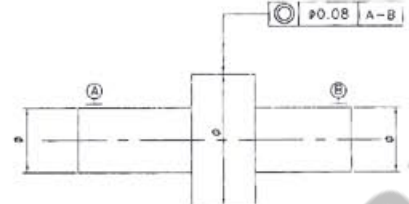
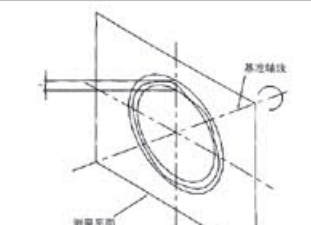
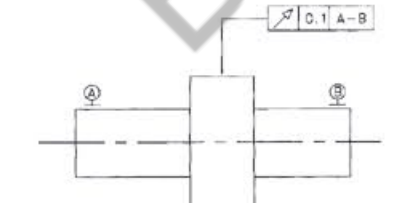
公差带定义 Definition of Tolerance Zone	标注和解释 Indication and Explanation
<p><b>垂直度</b> Perpendicularity Tolerance of a Surface</p>  <p>公差带是距离为公差值t且垂直于基准线的两平行平面之间的区域。 The tolerance zone is limited by two parallel planes a distance apart and perpendicular to the datum.</p>	 <p>被测面必须位于距离为公差值0.08且垂直于基准线A(基准轴线)的两平行平面之间。 The extracted (actual) surface shall be contained between two parallel planes 0.08 apart that are perpendicular to datum axis A.</p>
<p><b>同轴度</b> concentricity Tolerance of a point</p>  <p>公差带是直径为公差值t的圆柱面内区域,该圆柱面的轴线与基准轴线同轴。 The tolerance zone is limited by a circle of diameter t, the tolerance value shall be preceded by the symbol F, the centre of the circular tolerance zone coincides with the datum point.</p>	 <p>大圆柱面的轴线必须位于直径为公差值t且与公共基准线A-B(公共基准轴线)同轴的圆柱面内。 The extracted (actual) median line of the tolerance cylinder shall be within a cylindrical zone of diameter t, the axis of which is the common datum straight line A-B.</p>
<p><b>圆跳动</b> Circular run-out Tolerance</p>  <p>公差带是在垂直于基准轴线的任一半径位置的测量平面内,半径差为公差值t且圆心在基准轴线上的两同心圆之间的区域。 The tolerance zone is limited within any cross-section perpendicular to the datum axis by two concentric circles with a difference in radii of t, the centers of which coincide with the datum.</p>	 <p>当被测要素围绕公共基准线A-B(公共基准线)旋转一周时,任一测量平面内的径向圆跳动均不得大于0.1。 The extracted (actual) line in any cross-section plane perpendicular to common datum straight line A-B shall be contained between two coplanar concentric circles with a difference in radii of 0.1.</p>

### 硬度换算表

Hardness Change

标准球	布氏硬度 10mm球 荷重3000kg		洛氏硬度 (3R)				维氏硬度 HV 荷重30kg
	Hult Green 球	碳化钨球	HRA 荷重60kg 金刚石	HRB 荷重100kg 1/16" 球	HRC 荷重150kg 金刚石	HRD 荷重100kg 金刚石	
-	-	-	92.5	-	80.5	-	1700
-	-	-	92.0	-	80.0	-	1600
-	-	-	91.5	-	79.0	-	1550
-	-	-	91.0	-	78.0	-	1500
-	-	-	90.5	-	77.0	-	1450
-	-	-	90.0	-	76.0	-	1400
-	-	-	89.5	-	75.0	-	1350
-	-	-	89.0	-	74.0	-	1300
-	-	-	88.5	-	73.0	-	1250
-	-	-	88.0	-	72.0	-	1200
-	-	-	87.5	-	71.5	-	1150
-	-	-	87.0	-	71.0	-	1140
-	-	-	86.5	-	70.0	-	1076
-	-	-	86.0	-	69.0	-	1004
-	-	-	85.6	-	68.0	76.9	940
-	-	-	85.3	-	67.5	76.5	920
-	-	-	85.0	-	67.0	76.1	900
-	-	767	84.7	-	66.4	75.7	880
-	-	757	84.4	-	65.9	75.3	860
-	-	745	84.1	-	65.3	74.8	840
-	-	733	83.8	-	64.7	74.3	820
-	-	722	83.4	-	64.0	73.8	800
-	-	710	93.0	-	63.3	73.3	780
-	-	698	82.6	-	62.5	72.6	760
-	-	684	82.2	-	61.8	72.1	740
-	-	670	81.8	-	61.0	71.5	720
-	615	656	81.3	-	60.1	70.8	700
-	610	647	81.1	-	59.7	70.5	690
-	603	638	80.8	-	59.2	70.1	680
-	597	630	80.6	-	58.8	69.8	670
-	590	620	80.3	-	58.3	69.4	660
-	585	611	80.0	-	57.8	69.0	650
-	578	601	79.8	-	57.3	68.7	640
-	571	591	79.5	-	56.8	68.3	630
-	564	582	79.2	-	56.3	67.9	620
-	557	573	78.9	-	55.7	67.5	610
-	550	564	78.6	-	55.2	67.0	600
-	542	554	78.4	-	54.7	66.7	590



### 硬度换算表

Hardness Change

布氏硬度 10mm球 荷重3000kg			洛氏硬度 (3R)				维氏 硬度 HV 荷重 30kg
标准球	Hult Green 球	碳化钨球	HRA 荷重60kg 金刚石	HRB 荷重100kg 1/6" 球	HRC 荷重150kg 金刚石	HRD 荷重100kg 金刚石	
-	535	545	78.0	-	54.1	66.2	580
-	527	535	77.8	-	53.6	65.8	570
-	519	525	77.4	-	53.0	65.4	560
505	512	517	77.0	-	52.3	64.8	550
496	503	507	76.7	-	51.7	64.4	540
488	495	497	76.4	-	51.1	63.9	530
480	487	488	76.1	-	50.5	63.5	520
476	479	479	75.7	-	49.8	62.9	510
465	471	471	75.3	-	49.1	62.2	500
456	460	460	74.9	-	48.4	61.6	490
448	452	452	74.5	-	47.7	61.3	480
441	442	442	74.1	-	46.9	60.7	470
433	433	433	73.6	-	46.1	60.1	460
425	425	425	73.3	-	45.3	59.4	450
415	415	425	72.8	-	44.5	58.8	440
405	405	405	72.3	-	43.6	58.2	430
397	397	397	71.8	-	42.7	57.7	420
388	388	388	71.4	-	41.8	56.8	410
379	379	379	70.8	-	40.8	56.0	400
369	369	369	70.3	-	39.8	55.2	390
360	360	360	69.8	(110.0)	38.8	54.4	380
350	350	350	69.2	-	37.7	53.6	370
341	341	341	69.7	(109.0)	36.6	52.8	360
331	331	331	68.1	-	35.5	51.9	350
322	322	322	67.6	(108.0)	34.4	51.1	340
323	313	313	67.0	-	33.3	50.2	330
303	303	303	66.4	(107.0)	32.2	49.4	320
294	294	294	65.8	-	31.0	48.4	310
284	284	284	65.2	(105.5)	29.8	47.5	300
280	280	280	64.8	-	29.2	47.1	295
275	275	275	64.5	(104.5)	28.5	46.5	290
270	270	270	62.4	-	27.8	46.0	285
265	265	265	63.8	(103.5)	27.1	45.3	280
261	261	261	63.5	-	26.4	44.9	275
256	256	256	63.1	(102.0)	25.6	44.3	270
252	252	252	62.7	-	24.8	43.7	265
247	247	247	62.4	(101.0)	24.0	43.1	260
243	243	243	62.0	-	23.1	42.2	255

### 硬度换算表

Hardness Change

布氏硬度 10mm球 荷重3000kg			洛氏硬度 (3R)				维氏 硬度 HV 荷重 30kg
标准球	Hult Green 球	碳化钨球	HRA 荷重60kg 金刚石	HRB 荷重100kg 1/6" 球	HRC 荷重150kg 金刚石	HRD 荷重100kg 金刚石	
238	238	238	61.6	99.5	22.2	41.7	250
233	233	233	61.2	-	21.3	41.1	245
228	228	228	60.7	98.1	20.3	40.3	240
219	219	219	-	96.7	(18.0)	-	230
209	209	209	-	95.0	(15.7)	-	220
200	200	200	-	93.4	(13.4)	-	210
190	190	190	-	91.5	(11.0)	-	200
181	181	181	-	89.5	(8.5)	-	190
171	171	171	-	87.1	(6.0)	-	180
162	162	162	-	85.0	(3.0)	-	170
152	152	152	-	81.7	(0.0)	-	160
143	143	143	-	78.7	-	-	150
133	133	133	-	75.8	-	-	140
124	124	124	-	71.2	-	-	130
114	114	114	-	66.7	-	-	120
105	105	105	-	62.3	-	-	110
95	95	95	-	56.2	-	-	100
90	90	90	-	52.0	-	-	95
86	86	86	-	48.0	-	-	90
81	81	81	-	41.0	-	-	85

### 公差等级

Tolerance Grade

DIAMETER	h5	h6	h7
0-3.0mm 0-0.11811 in.	0.004mm 0.00015 in.	0.006mm 0.00024 in.	0.010mm 0.00039 in.
3.001-6.0mm 0.11812-0.23622 in.	0.005mm 0.00020 in.	0.008mm 0.00031 in.	0.012mm 0.00047 in.
6.001-10.0mm 0.2362370 in.	0.006mm 0.00024 in.	0.009mm 0.00035 in.	0.015mm 0.00059 in.
10.001-17.0mm 0.39371-0.70866 in.	0.008mm 0.00031 in.	0.011mm 0.00043 in.	0.018mm 0.00071 in.
18.001-30.0mm 0.90867-1.18110 in.	0.009mm 0.00035 in.	0.013mm 0.00051 in.	0.021mm 0.00083 in.
30.001-50.0mm 1.8111-1.96850 in.	0.011mm 0.00043 in.	0.016mm 0.00063 in.	0.025mm 0.00098 in.



# ❖ COMPANY PROFILE ❖

Jiangxi Jiangwu Cemented Carbide Co., (JTCC for short) is a wholly-owned by Jiangxi Rare Earth and Rare Metals Tungsten Group Corporation LTD.(JXTC for short).

The JTCC is an important enterprise of JXTC for "let the tungsten form source to deeper machining products" development strategy, producing and sale cemented carbide ready to press powder and many kinds products. In 2011,the company import most advanced equipments and process in the world to building a new production line for indexable inserts and could provide many kinds indexable inserts made of the brands including physical, chemical coating and metal ceramic, to use for high-precision turning, milling, drilling, cutting off, grooving and threading machining etc. also provide all kinds support and technical advisory services for metal cutting tools needed by car ,aviation, spaceflight and mould manufacturing industries.

The company has been qualified ISO9001-2008 certificate and ISO14001-2004 environment management certificate Company adheres to the philosophy of "Refining Quality, Optimizing management" which ensures to provide high quality products and excellent service.

Company located in the northwest of Jiangxi, distance 37Km form provincial capital Nanchang, and has entered one-hour economic circle of Nanchang.

## Quality guaranteed

We have been awarded GB/T19001-ISO9001 Quality System Certificate.

All our products are inspected strictly.

